

WWW.SURVIVALEBOOKS.COM

YOUR LAST LINE IN DEFENSE AND SURVIVAL

CHECK OUT OUR WEBSITE SOME TIME FOR PLENTY OF ARTICES ABOUT SELF DEFENSE,
SURVIVAL, FIREARMS AND MILITARY MANUALS.

<http://www.survivalebooks.com/>

Thank you for purchasing our ebook package.

METAL BODY REPAIR

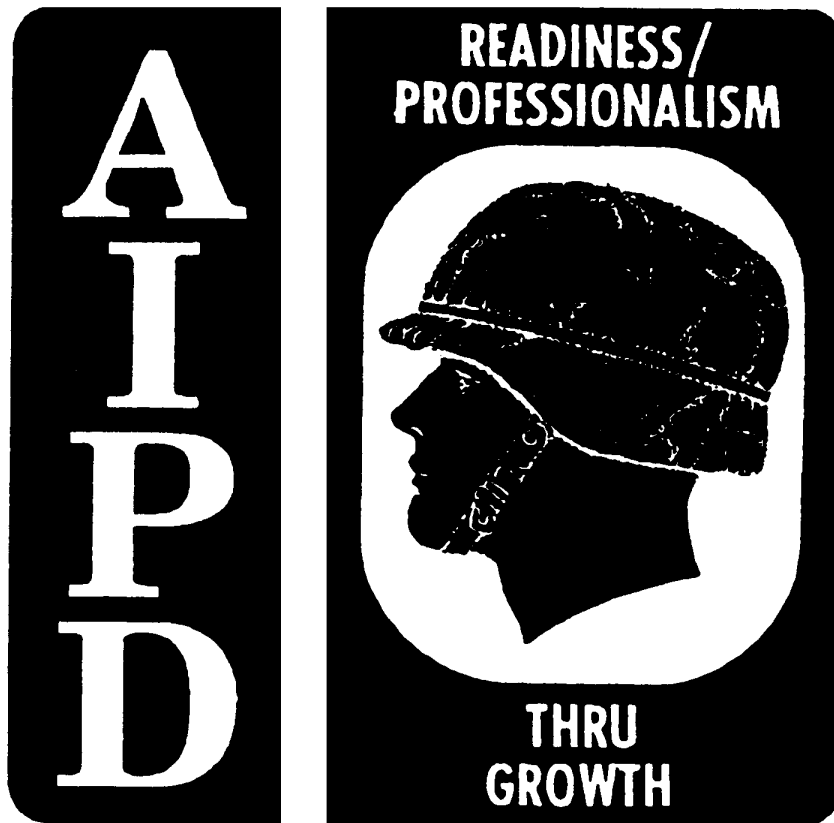

**THE ARMY INSTITUTE FOR PROFESSIONAL DEVELOPMENT
ARMY CORRESPONDENCE COURSE PROGRAM**

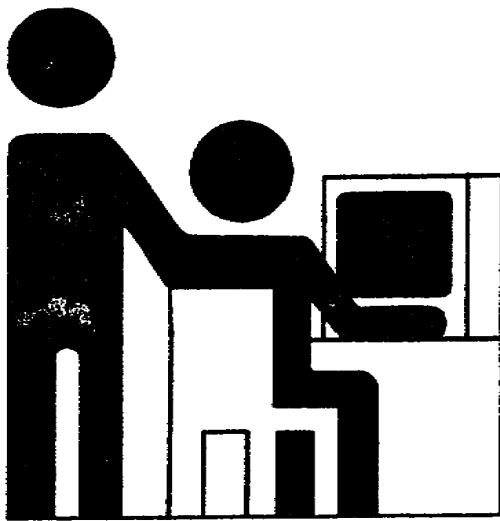

Notice to Students

Use the Ordnance Training Division website,
<http://www.cascom.army.mil/ordnance/>,
to submit your questions, comments, and suggestions
regarding Ordnance and Missile & Munitions
subcourse content.

If you have access to a computer with Internet capability and can receive e-mail, we recommend that you use this means to communicate with our subject matter experts. Even if you're not able to receive e-mail, we encourage you to submit content inquiries electronically. Simply include a commercial or DSN phone number and/or address on the form provided. Also, be sure to check the Frequently Asked Questions file at the site before posting your inquiry.

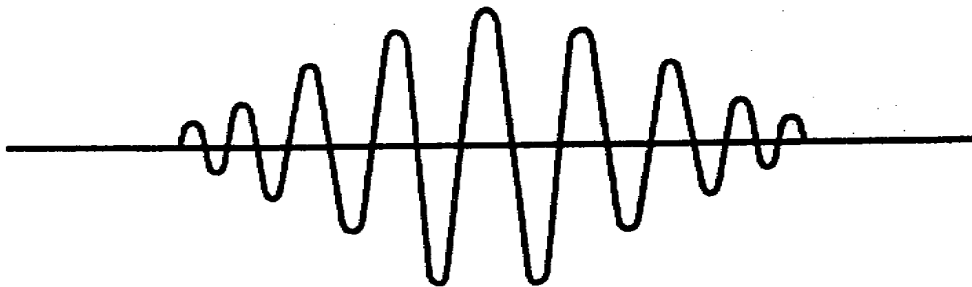

US ARMY REPAIR SHOP TECHNICIAN
WARRANT OFFICER ADVANCED COURSE

MOS/SKILL LEVEL: 441A

METAL BODY REPAIR

SUBCOURSE NO. OD1653

US Army Correspondence
Course Program

7 Credit Hours

GENERAL

The purpose of this subcourse is to introduce various operations required to repair damaged vehicles and specifically describe the repair procedures required for proper glass, radiator, and fuel tank repair.

Seven credit hours are awarded for successful completion of this subcourse which consists of two lessons divided into tasks as follows:

Lesson 1: OPERATIONS REQUIRED TO REPAIR DAMAGED VEHICLES AND COMPONENTS

TASK 1: Describe the operations required to repair damaged vehicles and components.

Lesson 2: OPERATIONS REQUIRED FOR GLASS, RADIATOR, AND FUEL TANK REPAIR

TASK 1: Describe the operations required for proper glass repair.

TASK 2: Describe the operations required for proper radiator repair.

TASK 3: Describe the operations required for proper fuel tank repair.

METAL BODY REPAIR - 0D1653

TABLE OF CONTENTS

Section	Page
TITLE.....	i
TABLE OF CONTENTS.....	ii
Lesson 1: OPERATIONS REQUIRED TO REPAIR DAMAGED VEHICLES AND COMPONENTS.....	1
Task 1: Describe the operations required to repair damaged vehicles and components.....	1
Practical Exercise 1.....	48
Answers to Practical Exercise 1.....	50
Lesson 2: OPERATIONS REQUIRED FOR GLASS, RADIATOR, AND FUEL TANK REPAIR.....	55
Task 1: Describe the operations required for proper glass repair.....	55
Task 2: Describe the operations required for proper radiator repair.....	67
Task 3: Describe the operations required for proper fuel tank repair.....	87
Practical Exercise 2.....	96
Answers to Practical Exercise 2.....	99
REFERENCES.....	101

THIS PAGE INTENTIONALLY LEFT BLANK

METAL BODY REPAIR - OD1653 - LESSON 1/TASK 1

LESSON 1

OPERATIONS REQUIRED TO REPAIR DAMAGED
VEHICLES AND COMPONENTS

TASK 1. Describe the operations required to repair damaged vehicles and components.

CONDITIONS

Within a self-study environment and given the subcourse text, without assistance.

STANDARDS

Within three hours

REFERENCES

No supplementary references are needed for this task.

1. Introduction

In order to replace or repair damaged sections of an auto body, the technician must begin with a thorough understanding of how the vehicle is constructed. The major elements of auto body construction are therefore discussed first in this lesson. Although the construction of the auto body may seem complicated, with conscientious study and a sincere desire to learn, the major principles may be acquired quickly.

Without a clear understanding of the basics of vehicle construction and assembly, it would be very difficult to follow correct repair procedures. Work improperly done, because of a lack of knowledge about vehicle construction, may result in unsafe conditions which endanger the lives of drivers and their passengers.

Vehicle body construction is a broad topic and cannot be treated exhaustively in this lesson. The mechanic who plans to do major collision repair

METAL BODY REPAIR - OD1653 - LESSON 1/TASK 1

work should also study body construction diagrams in manuals published by the leading auto manufacturers. Such study, plus repeated examination of actual vehicles, is the best course to follow in gaining a thorough familiarity with vehicle construction principles.

The successful auto body technician likes to do mechanical work and has the ability to plan, step-by-step, each job through completion. Seldom are two jobs the same; so the technician should be creative in planning the work procedure. Because the outer panels are shaped to relate to the total design of the vehicle, the technician must also have an artistic appreciation for the work. Pride in work is very important in a field where a slight imperfection can ruin a whole job.

Typically, the technician begins by removing trim components, body hardware, and accessories in order to gain access to the damaged metal by a process called bumping, using dolly blocks and special hammers. If damage is more extreme, hydraulic jacking equipment may be used to align a damaged area. Tiny nicks and dents are usually removed with special pick tools.

Each damaged vehicle presents a special repair problem because of the many kinds of damage which may occur. The technician seldom works at one particular job for any great length of time. He or she is expected to be skillful in many widely different areas of work, and to have the ability to see the entire job through to completion. In order to be successful, the technician should have a good understanding of vehicle construction, seeing how and why the parts fit together to form the total vehicle body. Pride in workmanship is very important. Failure to do quality work at any point during the repair may cause great problems later on.

2. Body and Frame Construction

a. *Body Construction.*

(1) *Bodies.* Passenger cars and truck bodies differ a great deal in construction because of the different purposes for which they are intended. However, each has an inner and outer construction. Outer construction is considered that portion of a

panel or panels which is visible from the outside of the vehicle. Included in the inner construction are all braces, brackets, panels, etc. that are used to strengthen the vehicle body. A general assumption is that inner construction cannot be seen from the outside of the vehicle.

(2) *Body Construction.* The main body components are shown in figure 1. Cowl or dash panel assemblies for the front end of the body are usually formed by assembling several smaller panels. These are the cowl upper panel and the cowl side panels that are joined by welds into one solid unit. The cowl extends upward around the entire windshield opening with the upper edge of the cowl panel forming the front edge of the roof panel. Windshield pillars are part of the cowl panel. They are the narrow sloping constructions at either side of the windshield opening. The cowl is sometimes referred to as the fire wall. The instrument panel is usually considered part of the cowl panel.

FIGURE 1. MAJOR SEDAN BODY COMPONENTS.

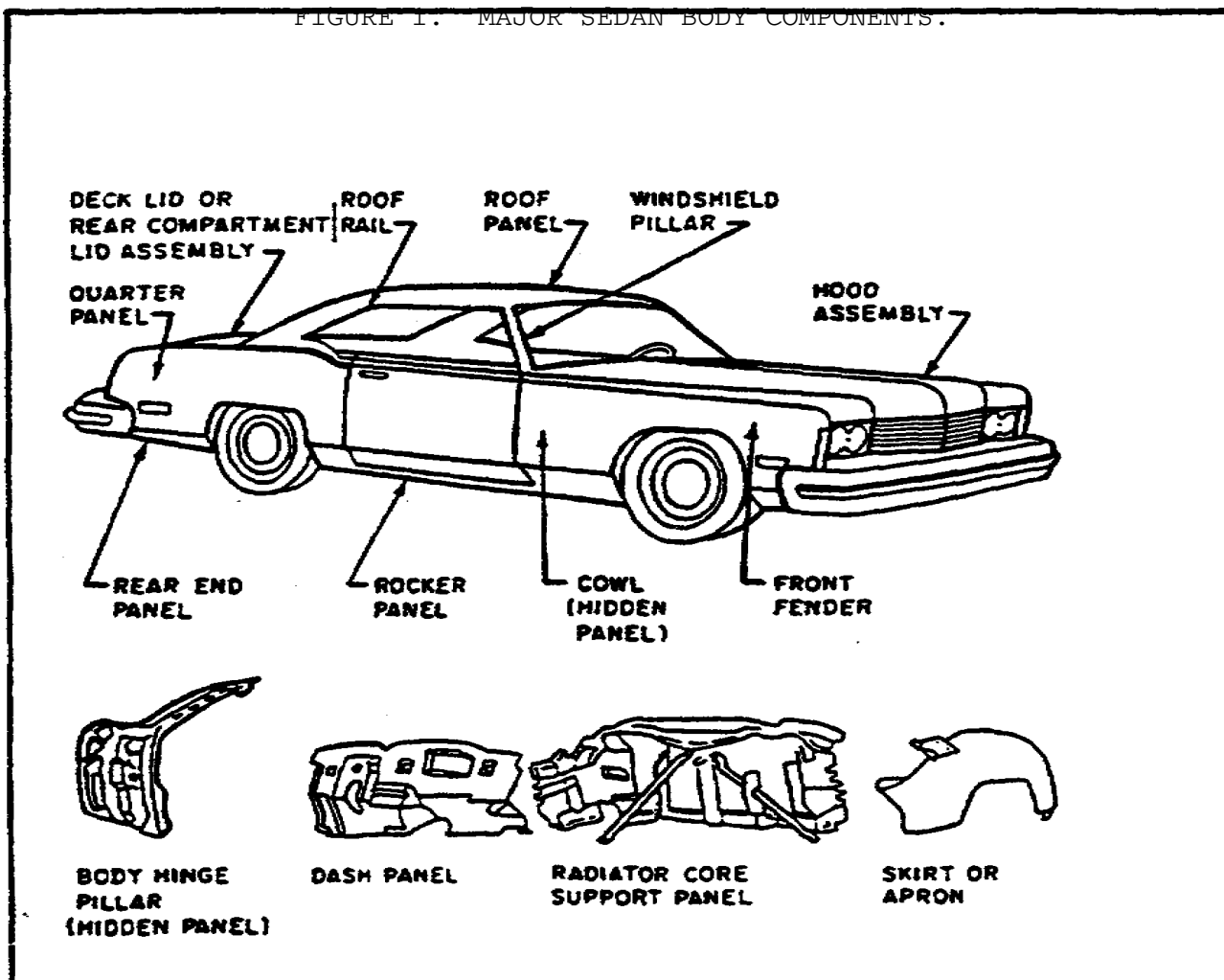

METAL BODY REPAIR - OD1653 - LESSON 1/TASK 1

(3) *Roof Panel Assembly.* The roof panel is one of the largest body panels, but it is also one of the simplest in construction. Usually, the roof is a one-piece steel construction. Some Army combat-type wheeled vehicles have a canvas top.

(4) *Floor Pan Assembly.* The floor pan is composed of several smaller panels that are welded together or secured to one another by bolts to form one single unit, as shown in figure 2. Most floor pans are irregularly shaped. They are indented or formed into bends to give strength to the entire floor structure.

FIGURE 2. FLOOR PAN ASSEMBLY

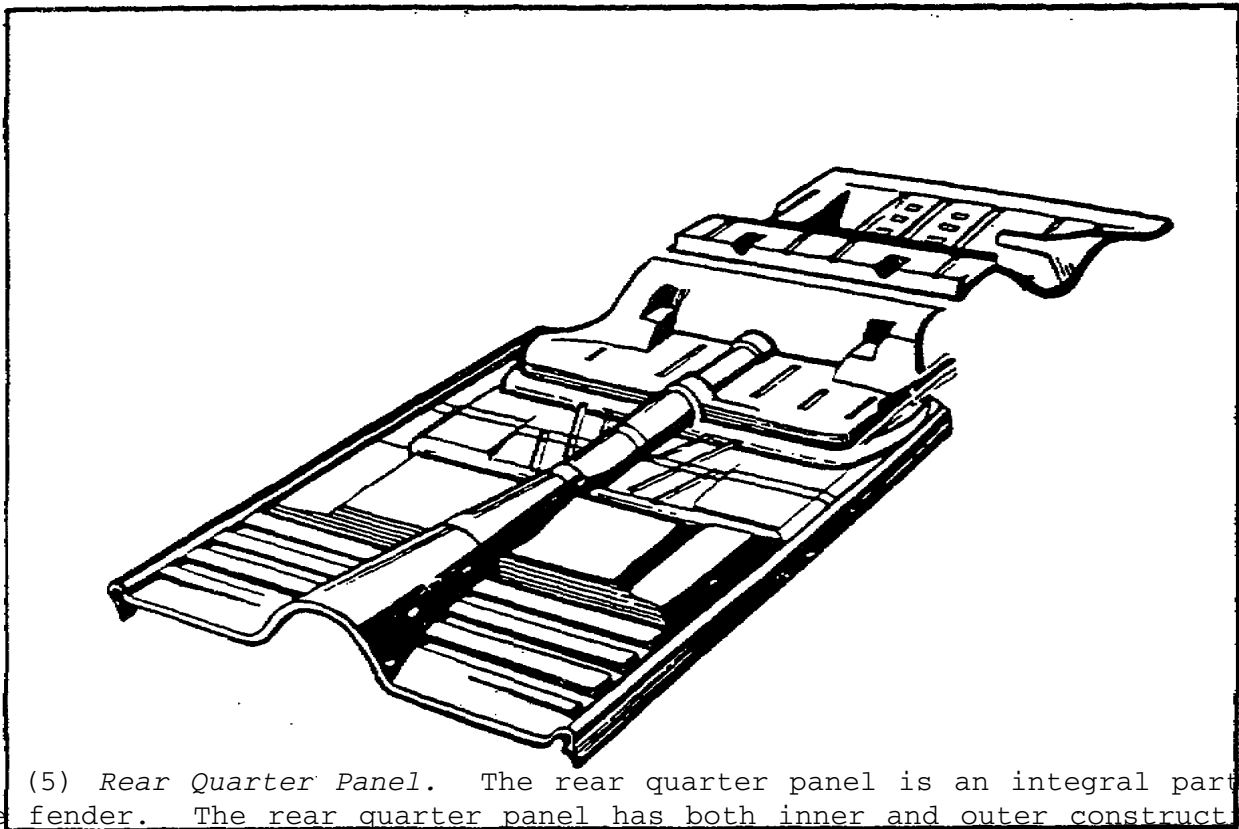

(5) *Rear Quarter Panel.* The rear quarter panel is an integral part of the fender. The rear quarter panel has both inner and outer construction. The outer construction or outer panel is smooth, except for the breaks caused by the design of the vehicle. The inner construction of a rear quarter panel is made up of many strong reinforcement brackets welded or bolted together to form a single unit.

(6) *Doors.* Doors are composed of two main panels: outer and inner. Both panels are normally

METAL BODY REPAIR - OD1653 - LESSON 1/TASK 1

of all steel construction. Doors derive most of their strength from the inner panel. The inner panel acts as a frame for the door. It is made with offsets and holes for the attachment of inner door hardware. The outer panel flanges over the inner panel edges to form a single unit. It also provides an opening through which the outside handle protrudes. In some instances, a separate opening is provided for the lock.

(7) *Deck Lid.* The deck lid is another door that allows access to the luggage compartment. It consists of an outer and inner panel. These panels are spot welded together along their flanged edges to form a single unit.

b. *Frame Construction.*

(1) An understanding of the construction of the frame is extremely important, since it is the foundation on which the vehicle is built. Frames of all types to fit all conditions are described and illustrated in this section. Frames can be constructed from channel stock, I-beam, angle, T-stock, Z-stock, tubing, flat plates, or a combination of any two or more of these stocks. Frames are usually wider at the rear than the front. This permits a shorter turning radius by allowing more room for the front wheels. It also allows more space for supported load carrying at the rear. The heaviest cross member is usually mounted under the front portion of the engine.

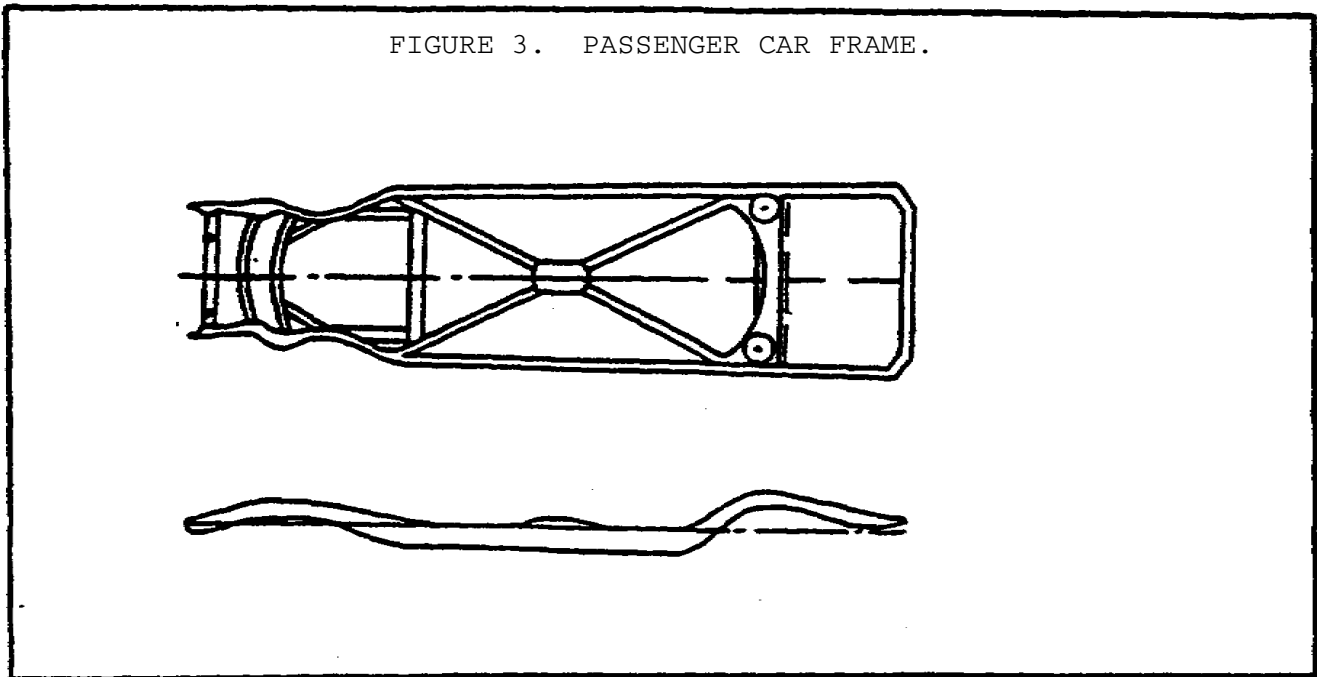

METAL BODY REPAIR - OD1653 - LESSON 1/TASK 1

(2) A typical passenger car frame is shown in figure 3 (on the previous page). This frame has an X-member in the center. For this reason, it is referred to as an X-type frame. You can also see from this illustration what is meant by the term "drop" used in connection with the frame. The main part or center of the frame is dropped down between the front and rear wheels. Repairs to a used body and frame are basically the same as repairs to separate body and frame-type vehicles.

(3) Metal repair procedures and straightening and squaring operations all apply, including the use of the hydraulic jack or other equipment. Avoid concentrating stresses in one spot by the use of blocks or plates of wood or metal in order to distribute the force. Avoid use of flame welding in repair, if possible, and do not apply excessive heat to the main frame members, as annealing and loss of strength may result. Most collision damage may be repaired by the use of jacks and bumping blocks or irons to reshape the damaged panels back to their original form. Usually, it is uneconomical to repair a body which has sustained damage to the main structural members severe enough to collapse the box section members.

(4) Surfaces to be welded must be free of dirt to prevent contamination of the weld. Use a wire brush or grinding wheel to remove rust, paint, and undercoating. All repair welding will be done by the electric arc process if possible. It is suggested that a low-hydrogen electrode, 3/32 inch diameter, be used.

(5) Depending upon individual conditions, spot welds may be repaired by drilling out and plug, puddle, skip weld, continuous weld, or an arc bead or fillet may be laid along the panel at that point.

(6) If 1/4 inch crown dimensions are exceeded, crossmembers must be straightened. Removal of the engine is necessary. Straightening can be accomplished with the use of C-clamps, hydraulic body jacks, and attachments. Heat should not be applied to aid the straightening process.

(7) With the exception of light vehicles, commercial vehicle frames are usually built flat. Light commercial vehicles are usually built on passenger car frames, or on a slightly stronger adaptation of a passenger car frame. Large truck and

bus frames are made flat without any drop, since a flat floor for the cargo or passenger carrying space is highly desirable. A low center of gravity is not as important a consideration for commercial vehicles as it is with passenger cars.

(8) Separate parts of automobile and truck frames are riveted together. Rivets are used because of their structural strength and their ability to give with the road condition. Before attempting to repair any frame, it is important to make an inspection to determine what, if any, damage or frame misalignment exists. Frame members often lose part of their original strength during the straightening process as a result of heating or excessive working to bring the parts back into alignment. It is possible that some frames have inherent weaknesses. Truck operations may result in shock loads which the manufacturer has not anticipated.

FIGURE 4. FRAME (CARGO, SHOP VAN, TANKER).

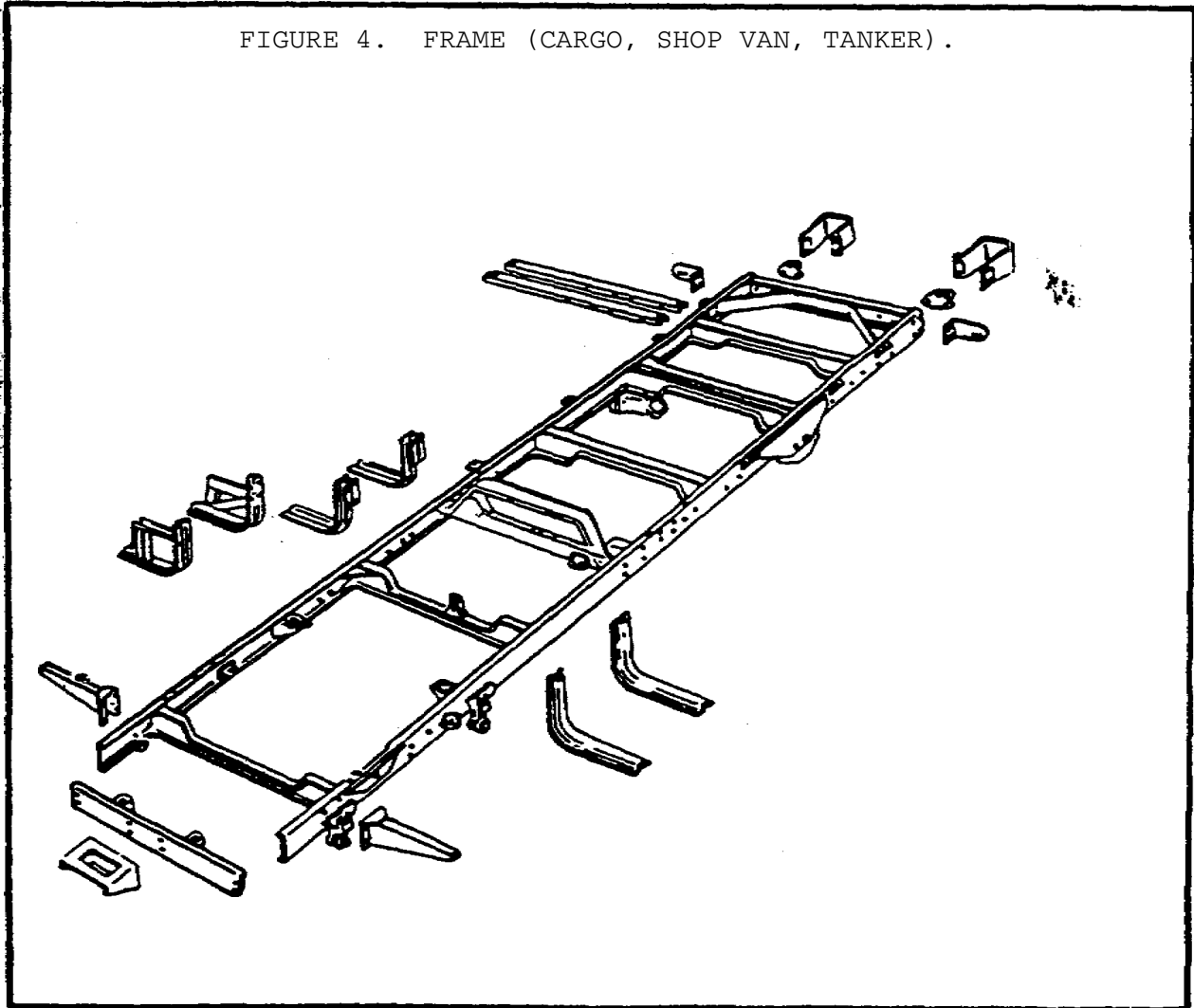

METAL BODY REPAIR - OD1653 - LESSON 1/TASK 1

(9) In these cases, the frame will have to be reinforced. For additional information on repair of frames, consult TB 9-2300-247-40. Figure 4 (on the previous page) shows a military truck chassis which is a standard frame for the cargo body, shop van body, tanker, repair van body of the 2 1/2 ton, 6 x 6 truck.

3. Metal Body Trim and Hardware

a. *General.* In the vehicle body, window openings are unsightly when viewed from the inside. They must have decorative trim to give them a finished appearance. In the vehicle body, finishing touches which are put on the outside as well as the inside are called either trim or hardware. On sedans, in addition to providing eye appeal, some trim is functional as well as decorative and contributes to the comfort and convenience of the passengers.

b. *Trim.* Moldings, floormats, armrests, head linings, door trim pads, and weatherstripping are known as trim.

c. *Hardware.* Door handles, window regulator handles, locks and window regulators, latches, hinges, seats, and seat adjustments are known as hardware.

d. *Grilles.* Grilles are sometimes referred to as trim. This would make it the largest single unit of trim. Grilles are usually made from several pieces of steel which are fastened together by nuts and bolts or by welding. In some cases, grilles are made from cast aluminum, white metal alloy, stainless steel, and steel stampings. On combat type vehicles, the grille is referred to as a brush guard. This grille (3/4 ton and over) is made from low-carbon steel stock and welded in place to form one single unit. The 1/4 ton vehicle grille is a one piece steel stamping bolted in place. Grilles are usually fastened in place by bolts which attach it to the front fenders. Brackets and supports are also provided which anchor it to the frame. Grilles are also fabricated from fiberglass and laminated material.

e. *Moldings.*

(1) Passenger car moldings are used freely both inside and out. Moldings differ in type and style

METAL BODY REPAIR - OD1653 - LESSON 1/TASK 1

depending on their use. Moldings are secured in place by retainers, screws, and special clips, except that moldings used around windshields and rear windows are held in place entirely by screws.

(2) Combat-type vehicle windows have very little, if any, outside moldings. Attractive appearance is not the main desire of a combat-type vehicle. Camouflage is often necessary during combat and if the vehicle is cluttered up with moldings shining in sunlight, troop positions could be revealed.

(3) Generally, the weatherstrip, which secures the windshield glass to the vehicle, is channeled to receive the outside reveal molding (the chrome strip on the outside of the vehicle around the windshield glass). The reveal molding is held in place by its own springback after it is inserted into the weatherstrip.

(4) The inside garnish molding, which fits on the inside of the vehicle around the windshield glass and other window openings, is fastened in place with sheet metal screws. Another arrangement of windshield installation is shown in figure 5.

(5) Windshields on combat-type vehicles are normally held together by a metal frame and sheet metal and machine screws and are attached to the body by hinges and brackets.

FIGURE 5. CROSS-SECTION OF WINDSHIELD WEATHERSTRIPPING AND MOLDING.

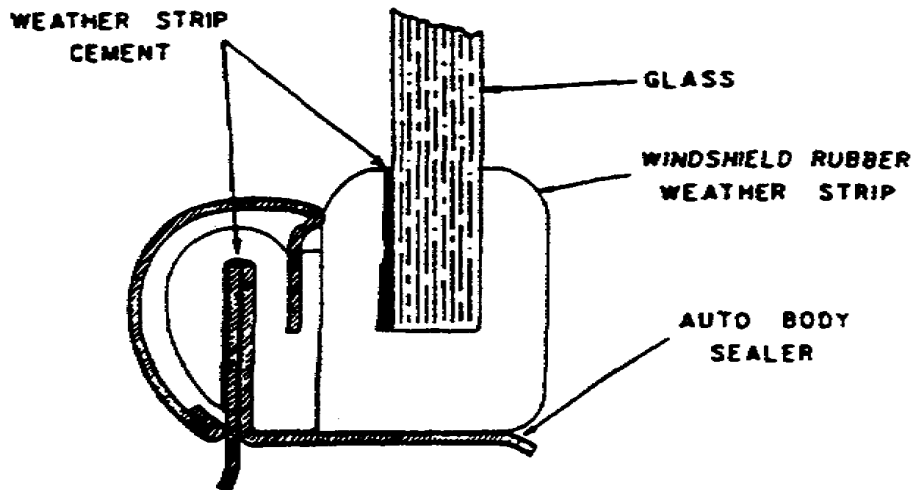

METAL BODY REPAIR - OD1653 - LESSON 1/TASK 1

(6) Moldings used around the rear windows are usually installed in the same manner as the windshields.

(7) Before moldings can be removed, it is necessary to break the seal between the weatherstrip and the body. This can be done easily by inserting a thin knife blade between the weatherstrip and the body, then running it along the length of the molding.

(8) Combat-type vehicles do not use a garnish molding. The door usually is of a one-piece construction. The door glass has a sheet metal frame that goes around it. The entire unit is secured to the lower glass channel with machine screws.

f. *Handles.*

(1) On some makes of sedans, the lock on the front door is constructed integrally with the door handle push button. On other makes, the locking mechanism is separate from the handle. A separate opening in the door panel is provided for the lock to be installed.

(2) Outside door handles extend through the outer panel into the inner panel where the linkage is connected to operate the latch mechanism. Door handles are fastened in place by means of a machine screw through the inner panel. Combat-type vehicle's outside door handles are fastened in place by two screws which are screwed into the outside door panel.

(3) Inside door handles are held in place by a push-fit pin that is concealed under the escutcheon when it is in place. An internal spring allows the escutcheon to be depressed for access to this retaining pin.

(4) Another type of door handle which is used on some vehicles has an integral handle and escutcheon held in place by a spring retainer or horseshoe clip.

(5) It is necessary to use a special pair of thin-nose pliers, or a flat tool made for this type of retaining pin, to remove the pin before the handle can be removed.

g. *Door Trim Pads.*

(1) Sedan door trim pads are used to conceal the lower portions of the inside panel of doors. The pads are usually prefabricated and assembled to the door as one unit. They are held in place by sheet metal screws and various types of spring clips.

(2) Combat-type vehicle doors are made in one piece. The only opening in the door (loading hole) is covered by a piece of sheet metal and is secured in place by sheet metal screws.

4. Metal Body Tools

a. *Hammers.*

(1) *Dinging hammer (A)* (figure 6). It is a general purpose hammer for use on any body panel. It has a 1 3/8 inch square face and 1 9/16 inch round face, and is made from drop forged alloy steel which has been heat treated.

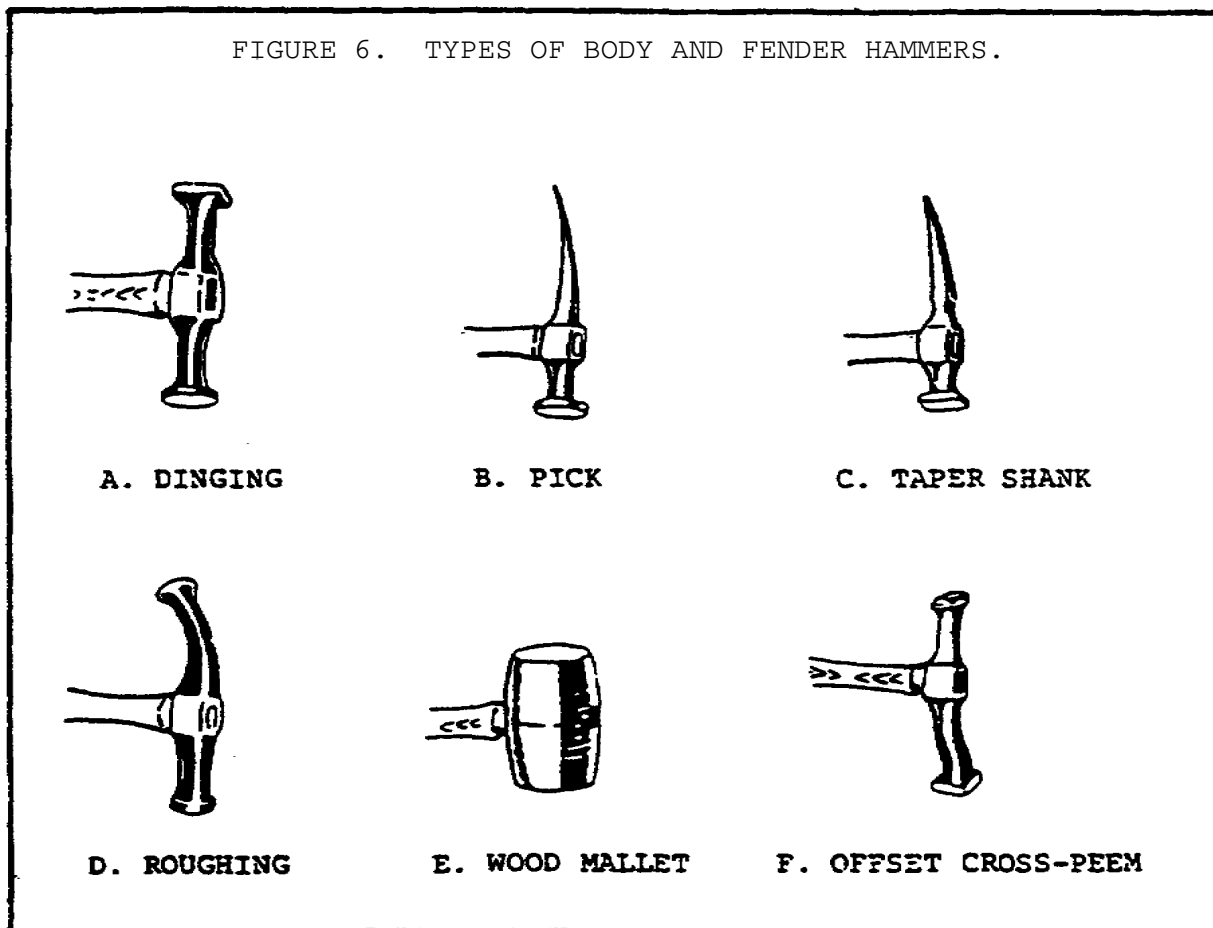

METAL BODY REPAIR - OD1653 - LESSON 1/TASK 1

(2) *Pick Hammer (B)* (figure 6 on the previous page). The painted shank of this hammer is used to raise small, low spots when crossfiling. It has a 1 9/16 inch round face and a curved shank tapering to a point. The bullet-type pick hammer (not shown) is designed for use on all industrial metal finishing and general dinging work.

(3) *Taper Shank Hammer (C)*. Designed for the latest metal bodies and fenders, it is used for reshaping all beads, moldings, headlamp insets, reveals, and louvers. It has a wide chisel face for rapid pick surfacing in large areas.

(4) *Roughing Hammer (D)*. Its curved shank reaches places not accessible to hammers of ordinary design, and its round face is ideal for working an extra heavy-gage metal.

(5) *Wooden Mallet (E)*. It is for use in connection with hot-metal shrinking, and for dinging soft metal such as aluminum, copper, and brass. It will not chip under ordinary usage.

(6) *Offset Cross-Peen Hammer (F)*. Its offset square face affords ample clearance without danger of striking adjoining panels. Its high crown cross-peen is designed for deep and narrow panels and return contours. The high crown may also be used in conjunction with the shrinking dolly to cold-shrink panels or sink welds.

b. *Dollies.*

(1) *Heel Dolly (A)* (figure 7A on the following page). It is shaped like the heel of a shoe, round face on one side and flat on the other. It may be used as a general purpose dolly.

(2) *High Crown (General Purpose) Dolly (B)*. It is precision ground for high-crown contours and is used in general body repair work. This tool is made from drop forged alloy steel.

(3) *Low Crown Dolly (C)*. It is used on all low crown panels. The hooks on the dolly are used on fender beads, drip moldings, and sharp, concaved moldings.

(4) *Shrinking Dolly (D)*. It is a specially designed combination high and low crown dolly. It has nine distinct contour combinations for hot and

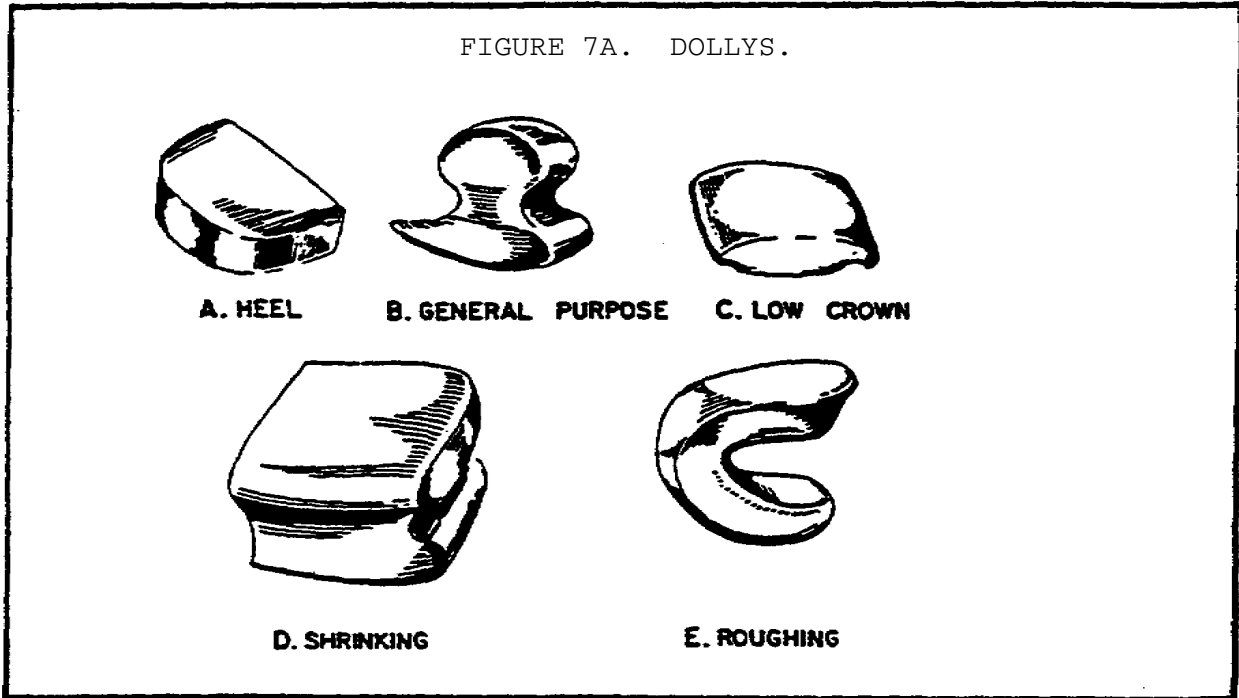

cold shrinking. It has wide and narrow trenching grooves for sinking welds.

(5) *Heavy Duty Roughing Dolly (E)* (figure 7A). It has a convenient grip and greater height to furnish extra backing for heavy duty hammering. It may be used in place of a roughing hammer for roughing out small dents. The lip at the end of its face is useful for reshaping turned-under flanges.

c. *Drip Molding Pliers* (figure 7B). Their accurately formed working faces permit extremely rapid roughing out for finishing with a suitable spoon. Made from drop forged steel, they are indispensable for pulling out crushed drip moldings.

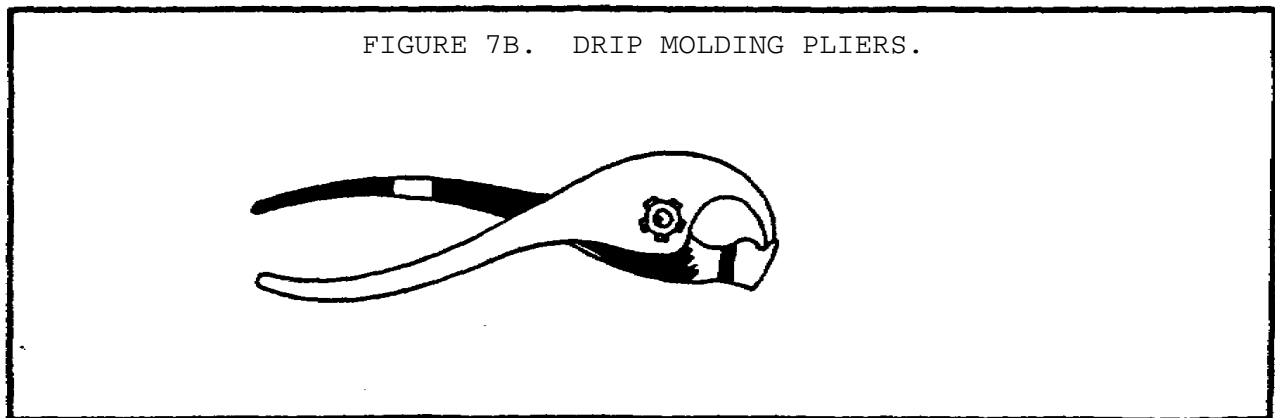

METAL BODY REPAIR - OD1653 - LESSON 1/TASK 1

d. *Body Spoons*. Body spoons are generally used for driving high spots back to their normal position without disturbing the surrounding surface. The working surface of each spoon is designed for a specific purpose. The more common varieties of spoons are the following:

(1) *Cowl Bracket (A)* (figure 8). Designed especially to hook over the fender brackets, it is used to work over cowl strainers and cowl brackets from post to dash and either high or low crown surfaces. It may be used as a dolly, so the wheel can be kept on when reaching a dent.

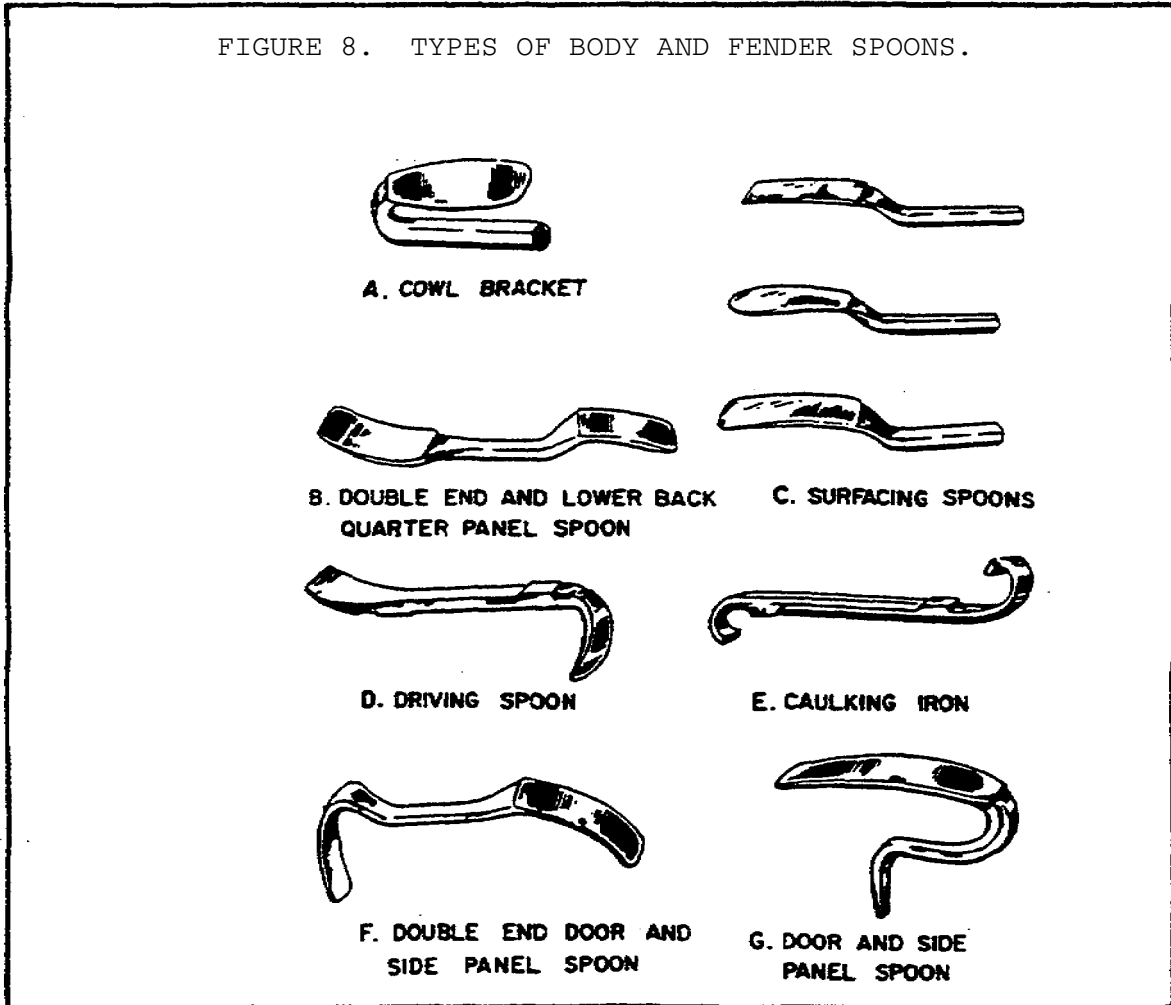

(2) *Double End and Lower Beck Quarter Panel Spoon (B)*. It is used for removing dents on quarter panels around rear pillars, behind inner construction, and behind back panel strainers. It may be used for removing dents from behind sills.

METAL BODY REPAIR - OD1653 - LESSON 1/TASK 1

(3) *Surfacing Spoon (C)* (figure 8 on the previous page). It is used for spring hammering operations with either the mallet or bumping hammer, and surface finishing. It is useful on all fender repairs and on high crown areas.

(4) *Double End Heavy Duty Driving Spoon (D)*. This is a general purpose utility spoon with a wide variety of uses. It is used to set inside seams of front fenders, bumping top rail panels, headlamp housings, hood louvers, and straightening and finishing drip molding and back panels. It may be used for general beasing work, lighting hinge pins, raising low spots, and for work around the ventilator in the cowl assembly.

(5) *Caulking Iron (E)*. A caulking iron is sometimes called a fender beading tool. It is a specially designed double end, heavy duty beading tool used for straightening all reverse bead on fenders with no wire, and turned under flanged edges. It may be used on return flanges or hoods, and for aligning inner construction on body panels. Its hammer pads provide a base for hammering operations.

(6) *Double End Door and Side Panel Spoon (F)*. Its precision ground face makes it useful as a dolly block in direct hammering. It is designed to reach the hard-to-get places behind inner construction on doors and cowl panels.

(7) *Special Door and Side Panel Spoons (G)*. The unusual length of this spoon, together with its shape, enables the workman to reach far behind construction and remove bumps from doors and trunk lids without cutting out the inner construction.

e. *File Bolder and Blade.*

(1) *Adjustable File Bolder*. This tool quickly adjusts from an extreme concave to an extreme convex profile. It has maximum utility for filing a wide variety of contours: round oval corners, upper and lower bracket panels, cowls, hoods, and top rail panels. It is used for flat work, high and low crowns, and on sweep surfaces.

(2) *Vixen File Blade*. This blade is detachable from the holder and is different from any other type file. These blades are accurately machined with unbroken cutting edges about 1/8 of an inch

METAL BODY REPAIR - OD1653 - LESSON 1/TASK 1

apart. Each cutting edge is curved with the cutting edge on the convex side. This blade has the cutting edges on each side, and the teeth run in opposite directions of each other to allow the blade to be turned over when one side becomes dull and unusable.

(3) *Maple Solder Paddle*. This paddle is made from maple wood because it does not split as easily as other woods. It is used to shape hot solder to the desired shape. It is used with motor oil, beeswax, or tallow to prevent the hot solder from sticking to the face of the paddle.

5. Metal Body Equipment

a. *Hydraulic Body Jack* (figure 9 on the following page).

(1) *Types*.

(a) *Direct Acting Jack*. This type jack has the power unit or hydraulic pump integral with the ram. The action may be only one direction, or it may work in either direction, push-pull.

(b) *Remote Controlled Jack*. In this type jack, the hydraulic power supply is separated from the ram unit of the jack. The two units are connected by a reinforced rubber hose.

(2) *Remote Controlled Jack Components*.

(a) *Pump (B)* (figure 9). It is hand-operated, with all controls on the unit. The pump also serves as the reservoir for hydraulic oil. The oil level should be periodically checked.

(b) *Ram (V)*. Threads on the ram are for attaching other jack attachments. If the jack is used without attachments, a thread protector must be used on the top of the ram body.

(c) *Flexible Rubber Heads (K)*. Two sizes of rubber heads suit most body needs. Rubber heads are generally used on dry painted surfaces because they will not slip or mar the surface. These heads should not be used in or near oiled surfaces as they can slip and cause further damage. Internal threads are provided for other jack attachments.

FIGURE 9. HYDRAULIC BODY JACK AND ATTACHMENTS.

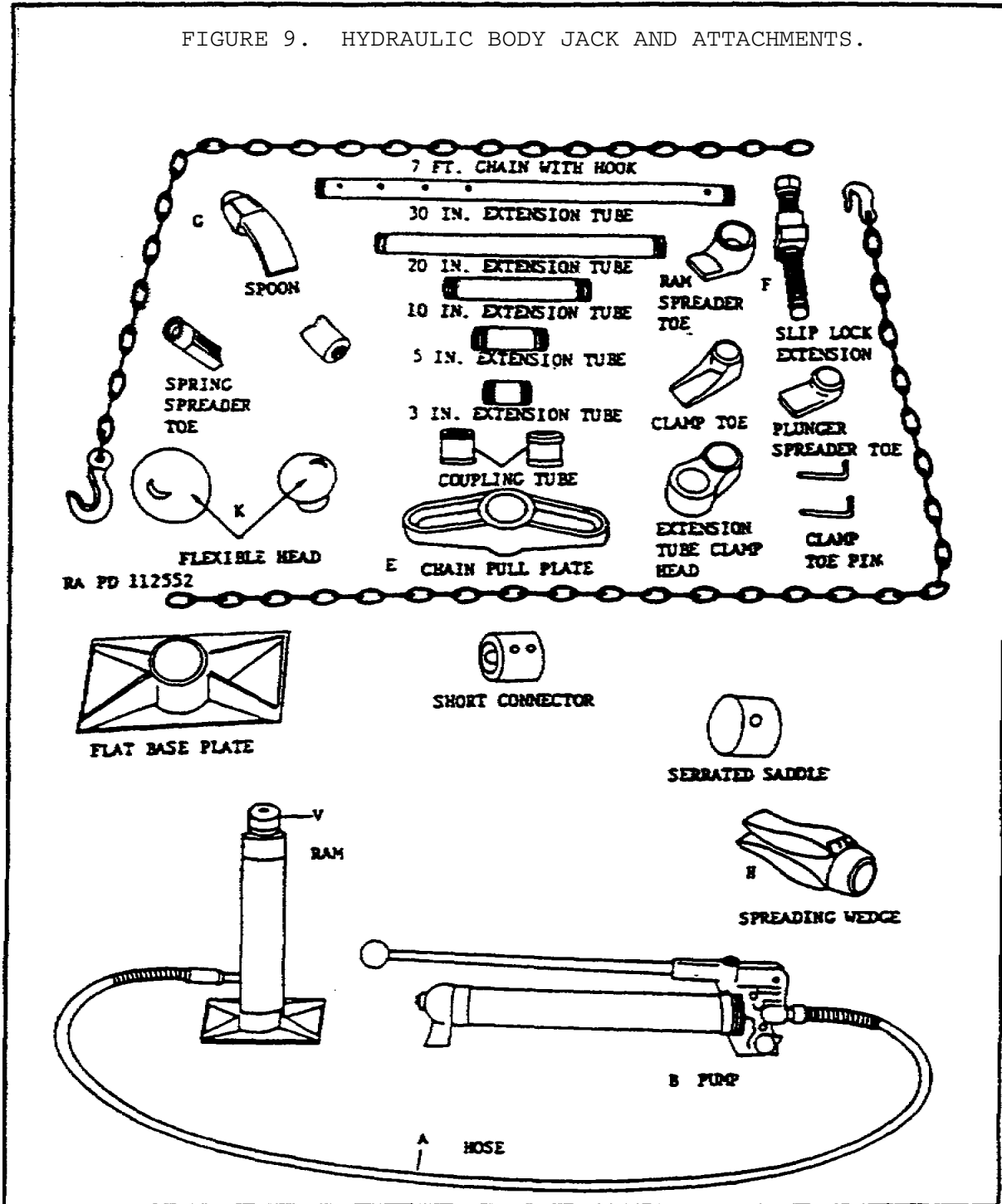

(d) Chain Pull Plate (E) (figure 9). This plate is used in most pulling operations. The plate has internal threads with slots on both sides for securing chains. It attaches to the ram body.

METAL BODY REPAIR - OD1653 - LESSON 1/TASK 1

(e) *Slip Lock Extension (F)* (figure 9 on the previous page). This tool gives six inches of prompt adjustment in pushing out large areas. A double friction lock holds securely at desired lengths, and is adjusted by a convenient double trigger release.

(f) *Rocker Spoon (G)* (figure 9). Specially designed for body work, it is held and locked in place by a hexagon pin. It may be set in many different positions. The selection of the spoon position is governed by the curvature of the body, the body bend or dent, and amount of working space.

(g) *Spreading Wedge (H)*. This tool is used for forcing out large or small concave areas and can be closed to one inch and opened to three inches.

b. *Electric Disk Sander*. The disk sander may be used to remove paint, reveal low spots, shape the contours of areas built up with solder, sand down welds, remove excess solder, remove rust, and remove deep scratches by using a fine abrasive sanding disk. It may be equipped with a flexible grinding wheel to serve as a grinder on thick sections of metal.

(1) *Backing Plate*. In most grinding, the disk is placed directly on the slightly flexible backing plate. Hard rubber and plastic can be used as backing plates. If a 9 inch sanding disk is used, it should have a 7 inch backing plate. The 7 inch backing plate will allow the 9 inch sanding disk outer edge to be cut down when it has become worn, increasing the disk life. Sanding disks are secured in place by a flat plate nut that is screwed onto the motor drive shaft and permits easy installation and removal of the plate nut when changing torn or worn-out disks.

(2) *Sanding Disks*.

(a) The coating abrasive disk does the cutting. Selection of the right grit and coating for each job is important.

1 Five different minerals are commonly used for manufacturing abrasives. Three of these, garnet, flint, and emery, are natural mineral abrasives. The other two are aluminum oxide and silicon carbide.

METAL BODY REPAIR - OD1653 - LESSON 1/TASK 1

2 Garnet, a semiprecious jewel, is the most important of the natural minerals.

3 Emery and flint break down easily and are better suited for household use than for industry.

4 For dry sanding, high quality hide glues are used for anchoring abrasive grains to the disk backing. For wet sanding, resins are used as the bonding agent.

(b) Coated abrasives fall into two additional classifications, based on how widely the minerals are spaced. If the minerals are close together, it is referred to as close coat. If the minerals are widely spaced, it is referred to as an open coat.

(c) Close coat abrasives are applied in such quantity as to completely cover the backing.

(d) Open coat abrasives are applied so as to cover from 50 to 75 percent of the backing.

(e) The open coating provides increased pliability and good cutting speed under light pressures. Open coated abrasives are used where the surface being ground is of such nature that closely spaced abrasive minerals would rapidly fill up, such as sanding paint or wood. Following is a suggested use of three of the most common disks.

1 The No. 24 disk is coated with a coarse open coat abrasive. It must be used with reasonable caution to prevent making deep scratches in the surface. This disk is most generally used in rough sanding surfaces that have been painted. Sand until a small volume of sparks is noticed coming from beneath the disk; when these appear, stop sanding.

2 Close coat No. 36 disk is used for several purposes in the body shop. It is most generally used for removing welds and in place of the body file in revealing high and low spots in the bumping operations.

3 Close coat No. 50 disk has only one function: performing finishing operations on metal surfaces such as steel and soldered panels. This disk will remove scratches left by No. 24 and No. 36 sanding disks.

METAL BODY REPAIR - OD1653 - LESSON 1/TASK 1

(f) When operating the sanding machine, hold it as flat as possible without allowing the drive shaft nut to come in contact with the surface being ground (figure 10). Hold the sander so that only 1 1/2 to 2 1/2 inches of the outer edge of the disk is in contact with the surface being ground. The sander must never be tilted so that only the edge of the disk contacts the surface. Failure to observe this will cause gouges or deep scratches in the metal that will be hard to remove. Move the sander from left to right, overlapping the previous stroke with each new stroke. Make the cutting lines as clean and straight as possible. Move the sander in the same manner whether you are removing paint, rough-grinding, or finish sanding.

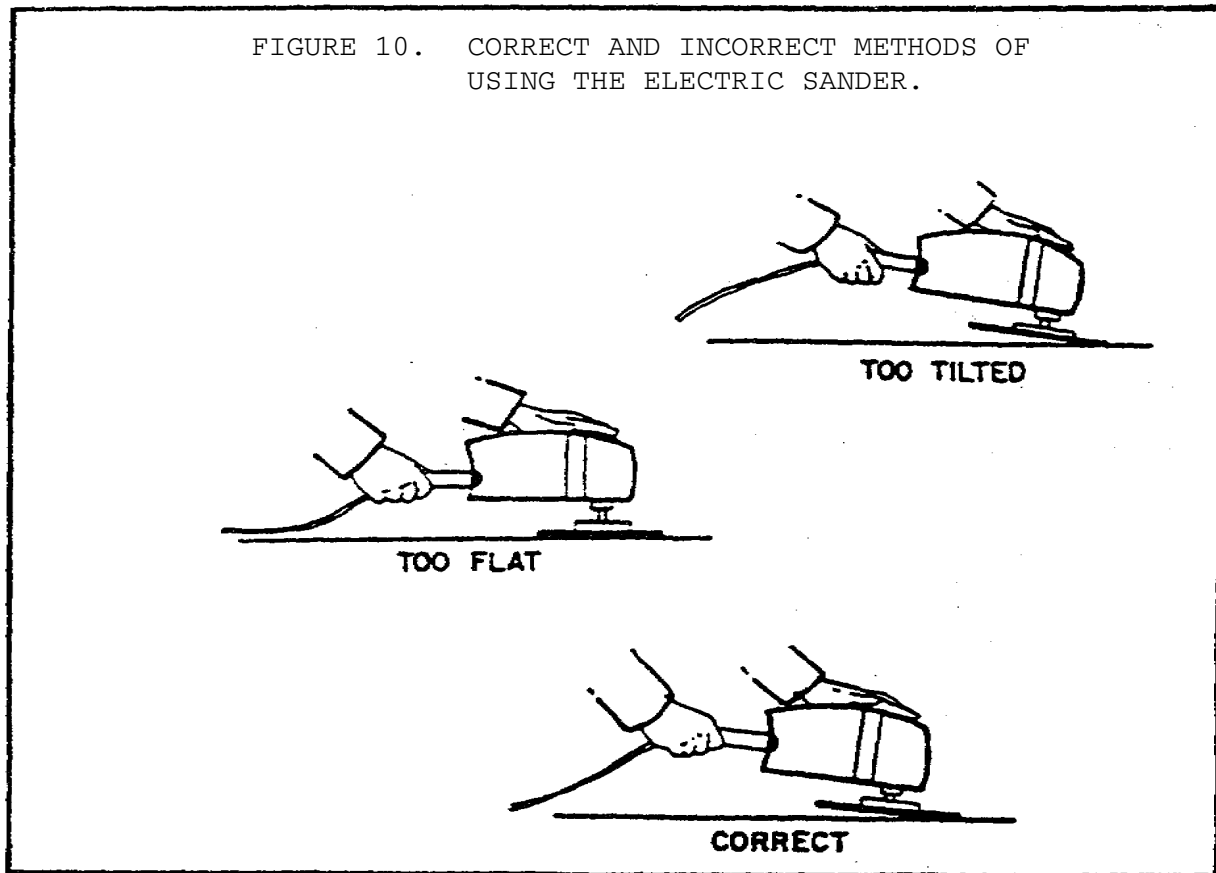

6. Measurement Principles

a. Damage to the body's inner construction or to the frame of a vehicle can be severe but not be apparent. Failure to check for and correct such damage can result in poor fitting doors, hoods, or fenders; faulty steering control; and many other problems. The possibility of these faults makes a

number of measurements necessary throughout the correction of collision damage. The measurements taken generally are not necessarily made in inches or feet, but rather are comparative measurements in which one measurement is compared, by means of a body tram, to another that should be equal (figure 11).

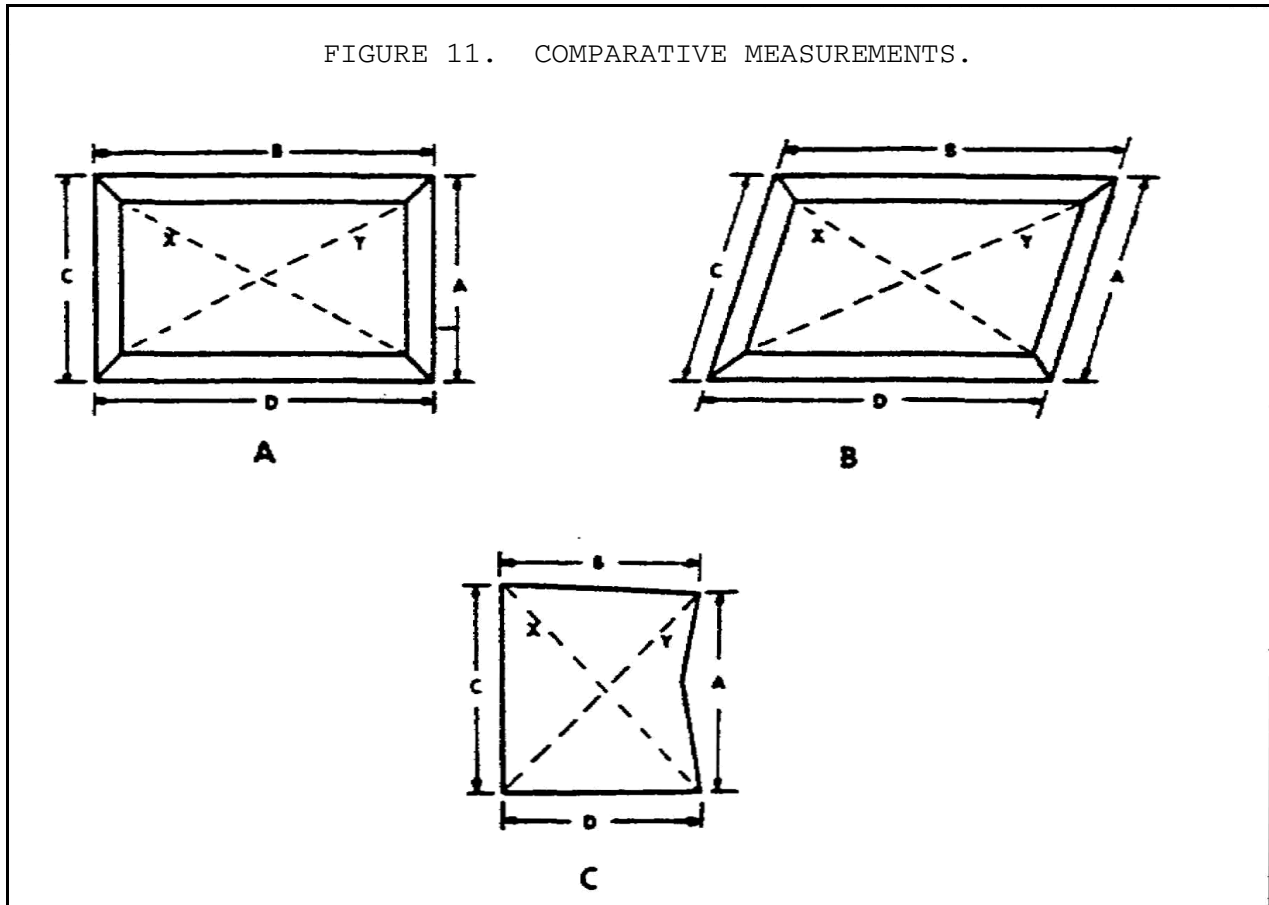

Vehicle bodies are regarded as having two sides which are exactly the same. Therefore, if only one side is damaged, it can be compared with measurements taken on the undamaged side. There is more to comparative measurement than comparing a damaged panel with a similar but undamaged panel. Occasions will arise when both sides of a vehicle are damaged, and it will be impossible to compare one side with the other.

b. *Comparative Measurement.*

(1) A metal picture frame is represented by (A) (figure 11) with opposite sides of equal length. Therefore, the diagonals X and Y are equal.

METAL BODY REPAIR - OD1653 - LESSON 1/TASK 1

(2) If the square is distorted, as shown in (B) (figure 11 on the previous page), the diagonals are no longer the same length; Y is no longer than X.

(3) If this figure frame (B) is visualized with movable corners, it can be seen where pressure must be applied to make it square; at the corners of the Y diagonal.

(4) The original length of either the sides or diagonals need not be known. By making comparative measurements of the diagonals, it will be shown that when they are again equal, the frame is again perfect as it was in (A).

(5) In (C), it is possible for the diagonals to be the same if the distortion is exactly at the mid point of side (A). Therefore, by a comparison of sides, (A) can be straightened until both side (C) and side (A) are the same length. These illustrations show how it is possible to align a body or frame by measuring the body or frame alone.

FIGURE 12. DIAGONALS OF CUBES ARE ALWAYS OF EQUAL LENGTH.

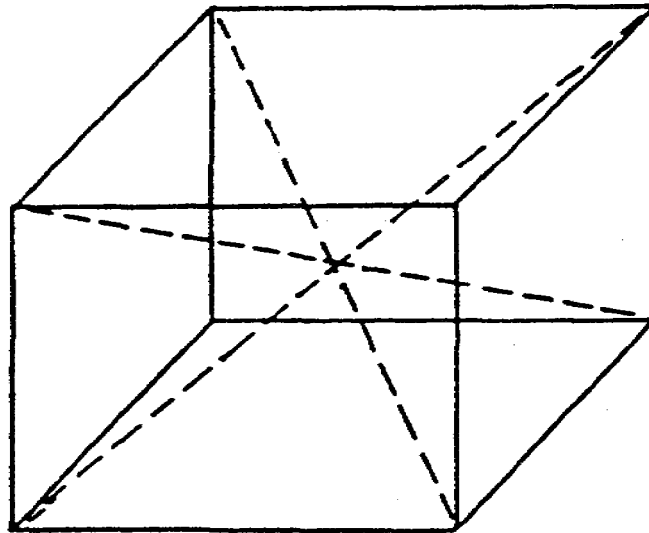

METAL BODY REPAIR - OD1653 - LESSON 1/TASK 1

(6) When an entire section of a vehicle is knocked out of alignment, another aspect of X-checking measurement must be considered. The body proper can be considered as a cube. It is a simple matter to determine whether or not a cube is square by checking the diagonals from opposite corners as shown in figure 12 on the previous page.

(7) The diagonals checked should be from one corner of the box to another so that they cross in the exact center of the cube.

(8) This same principle can be applied to measuring the cube-like sections of an automobile body.

(9) This method of checking can also be applied to checking one section with another section.

7. Body and Fender Repair Techniques

a. *General.* Restoring vehicle body panels of sheet metal to their normal contour after they have been damaged is referred to as metal bumping or dinging. Every job involved in metal bumping, requires fine handwork. To become a good metal body repairman, mastery of each phase of work is required. In collision work, use of the hammer is one of the most important functions.

b. *Analyzing Damage.*

(1) The ultimate success of any collision repair job depends on the accuracy of the analysis of what is damaged and how it occurred. Collision work must be approached on this basis, but goes a step further. Not only must you first determine what is wrong, but you must establish how it got that way and the order in which it happened.

(2) Although the straightening of body panels and fenders comprises the greatest volume of collision work, collision damage also occurs to the mechanical parts of the vehicle. The repair of mechanical parts is an important part of the total repair of collision damage. When you are finished repairing a vehicle damaged in collision or one that has turned over, it must run well, it must steer well, the brakes must operate properly, and all of the electrical units must be in operating condition. Although the correction of mechanical

METAL BODY REPAIR - OD1653 - LESSON 1/TASK 1

difficulties caused by the collision involves other skills and techniques than are practiced by the collision expert, he cannot ignore them and must provide for their correction.

(3) Each part of the damage occurred in a certain order. It is necessary to correct it in the reverse order of the way in which it occurred. Studying the damage permits you to reconstruct the sequence of events which caused the damage, thereby providing the proper order in which the damage should be corrected.

c. *Roughing and Aligning.*

(1) After analyzing the damage, the next step in body and fender repair is metal bumping (roughing) which is the important unlocking and unrolling operation. If this is done carelessly or hurriedly, new lines of strain will probably be set up, stretching and bending the metal at such sharp angles that a further rearrangement of the displaced fibers will be impossible.

(2) Before repairing fenders, scrape off any tar, gravel, or road dirt underneath the damaged part. Any dirt left on the underside will cake on the dolly block, so that hammering smooth will be impossible.

(3) The outside surface of the damaged fender or panel is then wiped with a rag which has a small amount of thin motor oil soaked into it. This removes dust and grit which would otherwise stick to the hammer face and hinder the worker from securing a smooth surface. The light reflected from the oiled surface shows the extent and depth of the various bumps.

(4) Since metal bumping and finishing are simply a matter of hammering, it should be learned at the outset how to use the hammer and dolly. The simple secret is to make every blow of the hammer strike the metal directly above the dolly or spoon.

(5) A simple application of the use of a hammer and dolly block is shown in figure 13 (on the following page). The downstroke of the hammer drives the high spot down onto the face of the dolly block, smoothing the metal. The dolly block absorbs the shock of the hammer blow and prevents the damaged metal from being driven down too far.

At the same moment, the dolly block bounces away from the under surface of the damaged metal and quickly rebounds against the low spots, raising them before the next stroke of the hammer. With free whipping blows of the hammer on the outside surface of the metal, the two handtools rapidly smooth the rough spot.

FIGURE 13. USING HAMMER AND DOLLY.

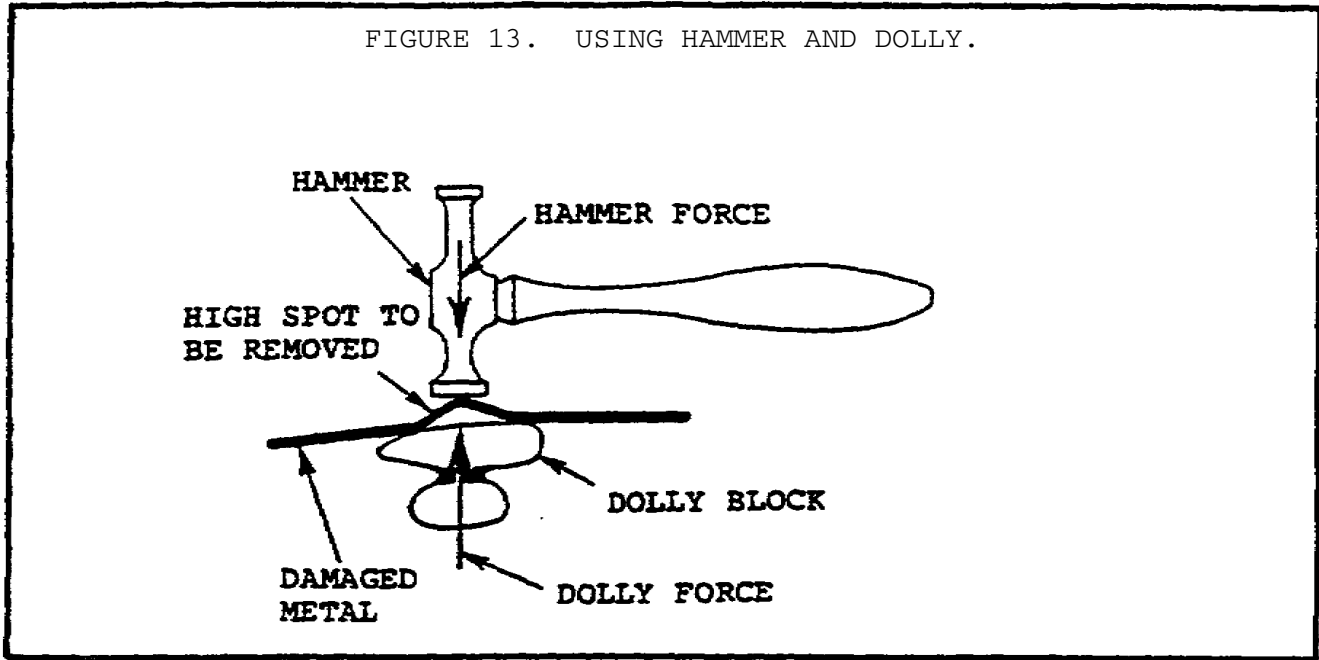

(6) Never grip the dolly tightly or apply any great amount of pressure on it, because the important automatic bounce and rebound of the dolly will be lost. Most repairmen naturally develop a rhythm of 60 to 150 successive hammer blows per minute as they become skillful. Bumping is only a matter of hammering the high spots down and bringing the low spots up until the damaged metal is again even in contour. Putting the high metal down first is very important.

(7) Figure 14 (on the following page) illustrates a simple damage which may occur to an outer door panel. The arrow indicates the direction of the damaging force. X marks the outer rim of the damaged area, and Y marks the point of impact of the hub. The line XY represents a cut at the bottom of one of the V-channels. Z marks the flanged edge of the panel which has been bent sharply by the panel's collapse. It is also locked.

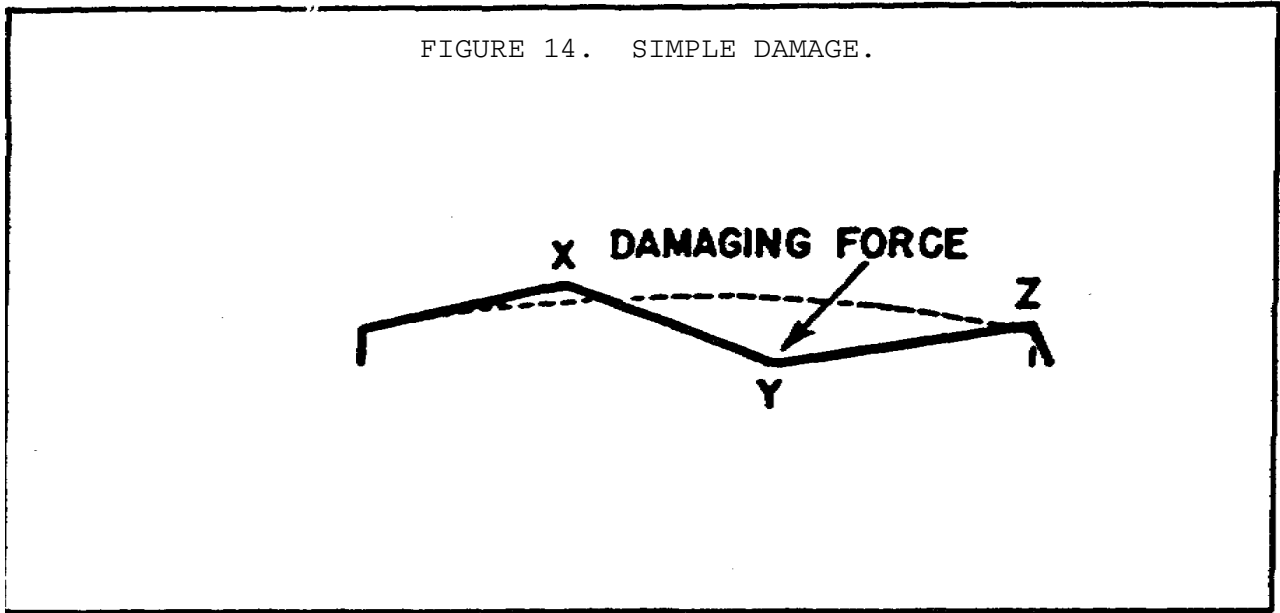

(8) Since ridge X is clearly the last created in the damage, it is the first strain to be unlocked. Place a low-crown dinging spoon on it (1) (figure 15 on the following page) and hammer the spoon sharply, directing the blows straight at the ridge. This unlocks the high metal and moves it back toward its original position.

Next, ding the flange corner Z, unlocking it. The areas of metal between O and Y and between Y and Z are now lying unlocked, ready to spring back to normal shape with very little help. Give this help with a medium-crown dolly block (2) (figure 15), unrolling the wave with two or three blows on the under side from O through Y. This unlocks the kinked metal at the bottom of the V-channel OY. Repeating this procedure from Z to Y restores the metal to the position shown in (3) (figure 15).

(9) Figure 16 (on page 28) illustrates the error of roughing out the same damage without first releasing the locked ridges. In (1) (figure 16), the caved in metal is being roughed out by striking the underside at Y with a dolly. This forces up a large area of the dent to nearly its normal shape. Note, however, that the strain in the ridge X has not been unlocked; the ridge does not come down to its normal place, but instead pulls the panel down abnormally at H. This happens because the locked ridge X reinforced and strengthened the metal on either side of it. Therefore, when force is applied upward at Y, the ridge acts as a fulcrum, pulling the metal down at H as it is forced up at Y.

FIGURE 15. REMOVING SIMPLE DAMAGE CORRECTLY.

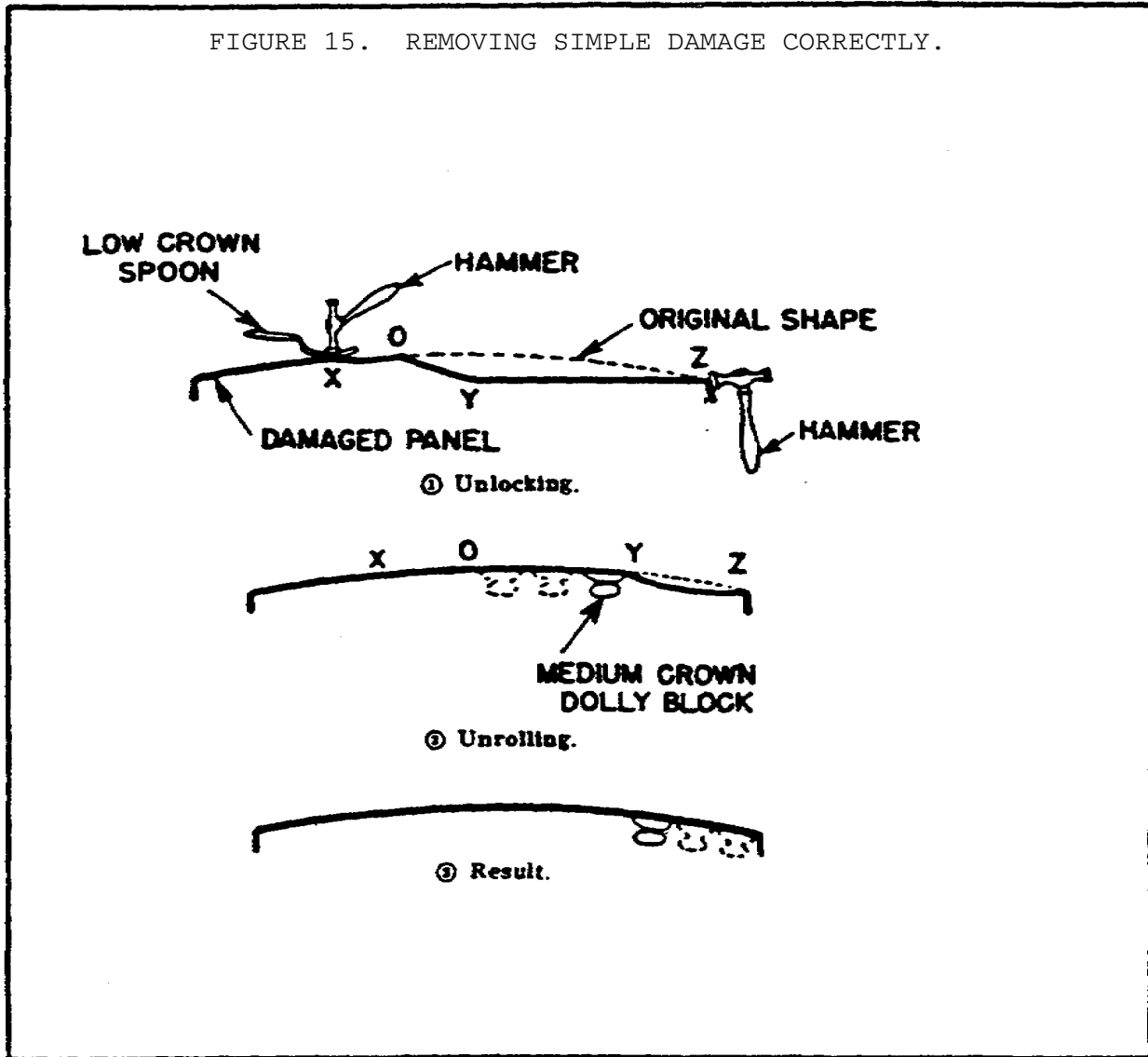

(10) Now that roughing out has been started without releasing the locked ridge, the metal must be stretched to raise it to its original level as indicated by the dotted line. So much force is now required to bring it up to place that it bumps and knots wherever it is struck by the dolly block, as shown in (2) (figure 16 on the following page). Equalizing all these bumps and knots means a lot of work. In (3) (figure 16), the dent has been roughed out and the hammer and dolly are in place to start smoothing.

(11) In (4) (figure 16 on the following page), the dent is restored to a normal shape. Note, however, that it is a new shape. Not only has time been wasted in unplanned bumping, but the metal has been stretched, as shown by the dotted lines, so

FIGURE 16. REMOVING SIMPLE DAMAGE INCORRECTLY.

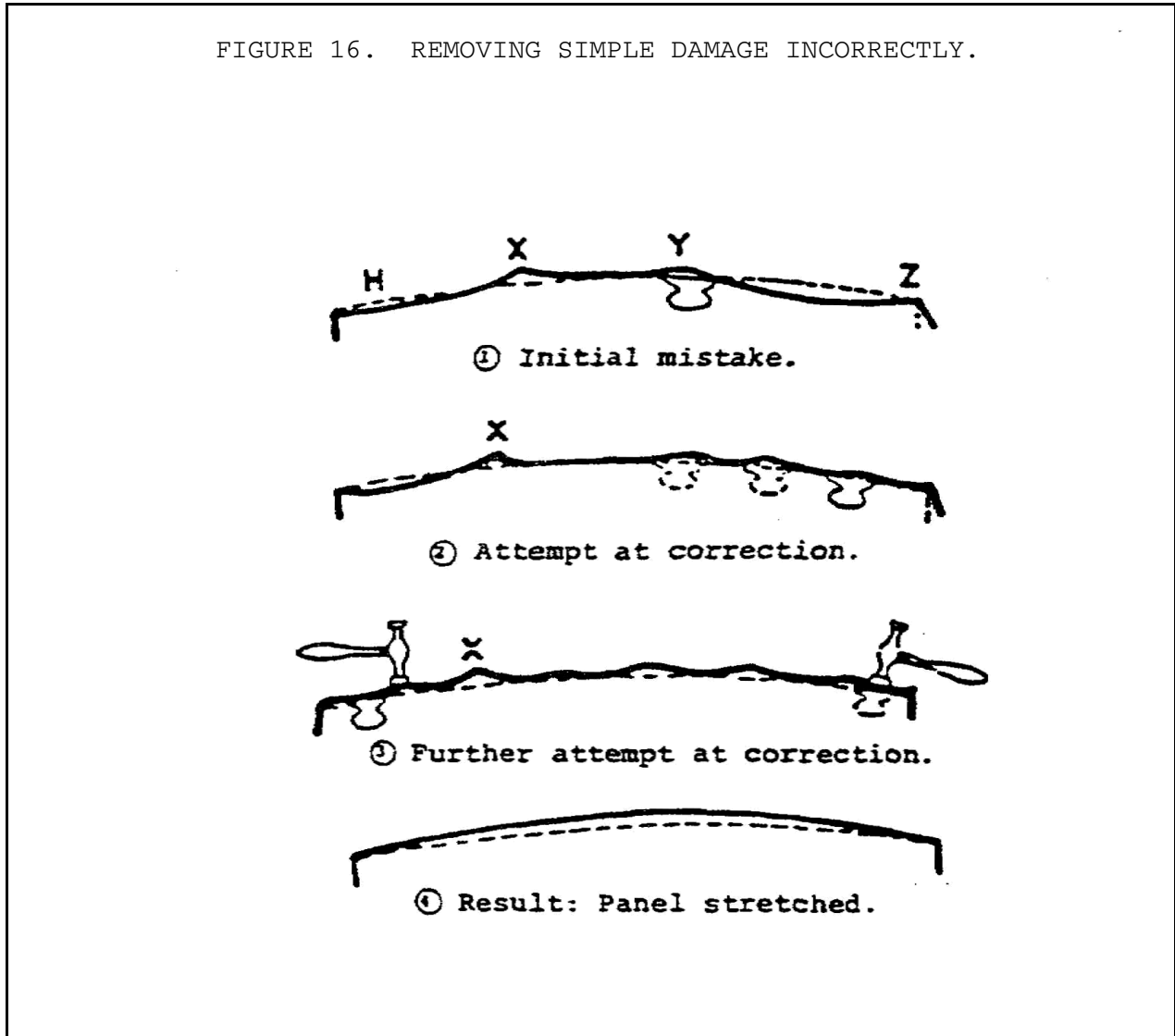

that the entire width of the panel, instead of only the damaged area, requires metal finishing.

(12) Alignment is squaring the damaged body of a motor vehicle by restoring its correct shape and dimensions. Misalignment may be checked by observation, but measurements are more accurate.

(13) The best measuring method of checking, known as X-checking, is simply an application of the principle that the diagonals of a true rectangle are equal in length. Some areas that must be checked, such as door openings, the front section (area between the cowl hinge pillars), and the center section (area between the central pillars), are not in themselves square, but

rectangles may be laid within them which provide good diagonal tests.

(14) The measuring device, called a tram (figure 17), is a telescoping tube equipped with an extension clamp which fixes it as the measurement of one diagonal for comparison with another.

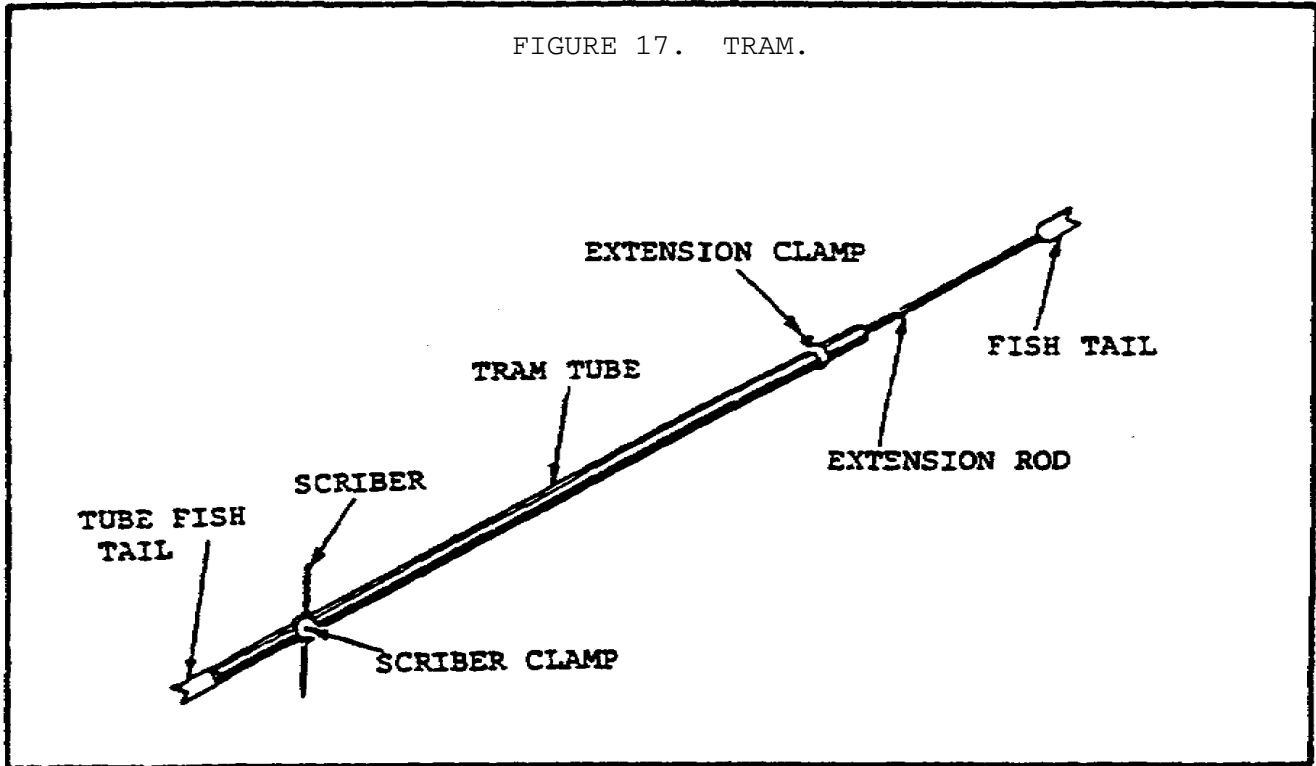

(15) Since most severe collisions distort the frame as well as the body of the motor vehicle, the frame must be checked and straightened first. Divide it into three rectangles, using as corners the front and rear spring shackles as in figure 18 (on the following page).

Then lay the tram at diagonal AB'; clamping it at the exact length of the diagonal. Remove the tram and check A'B to see whether this length is the same. In the same way check BC' against B'C and CD' against C'D. If there is any deviation of measurements, do not check body alignment until corrective forces have been applied to bring the frame into line.

FIGURE 18. X-CHECKING FRAME ALIGNMENT WITH TRAM.

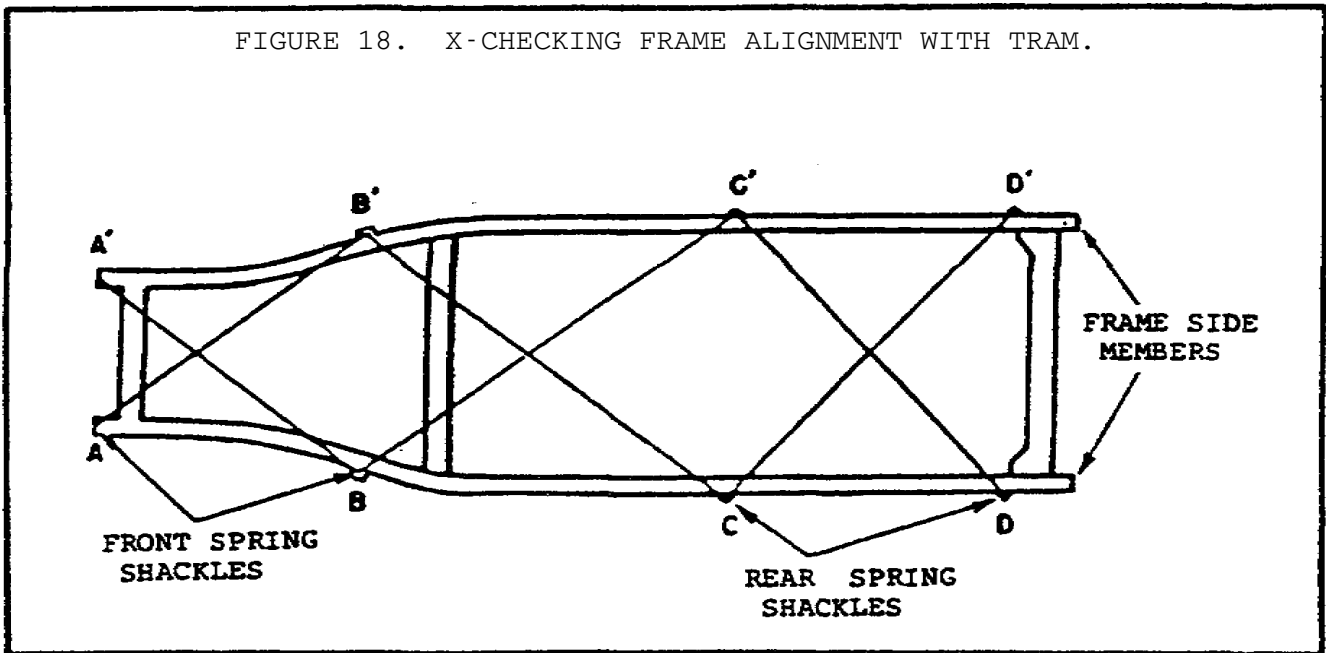

(16) Misalignment of a door opening in a body is generally checked by the fit of the door. However, it may also be checked by the tram as shown in figure 19 (on the following page). Measurements are taken by marking off a distance X along the center pillar from B to C and a distance Y along the body sill from B to A. Set the tram with its ends on points A and C and compare this length with similar points on the undamaged side of the vehicle or on a similar vehicle. Any misalignment of the door opening will be indicated by the necessity of resetting the tram.

(17) If both sides of the vehicle are damaged, lay out a rectangle such as A B C D which is shown in figure 19, in a correctly aligned door opening of a similar vehicle. Then measure the distance X and Y and transpose these measurements to the door opening of the damaged vehicle. If the diagonals A C and B D are not equal, the door opening is out of alignment.

(18) After the door openings on both sides of the vehicle have been checked, measure the front section in the same manner. In this measurement, the same points, A and D as before, are used together with points F and E in corresponding positions on the opposite door openings, to form the corners of a rectangle (figure 20 on the next page). The diagonals A E and D F should be equal. If they are not, the misalignment must be corrected before other checks are made on the body.

FIGURE 19. X-CHECKING DOOR OPENING ALIGNMENT WITH A TRAM.

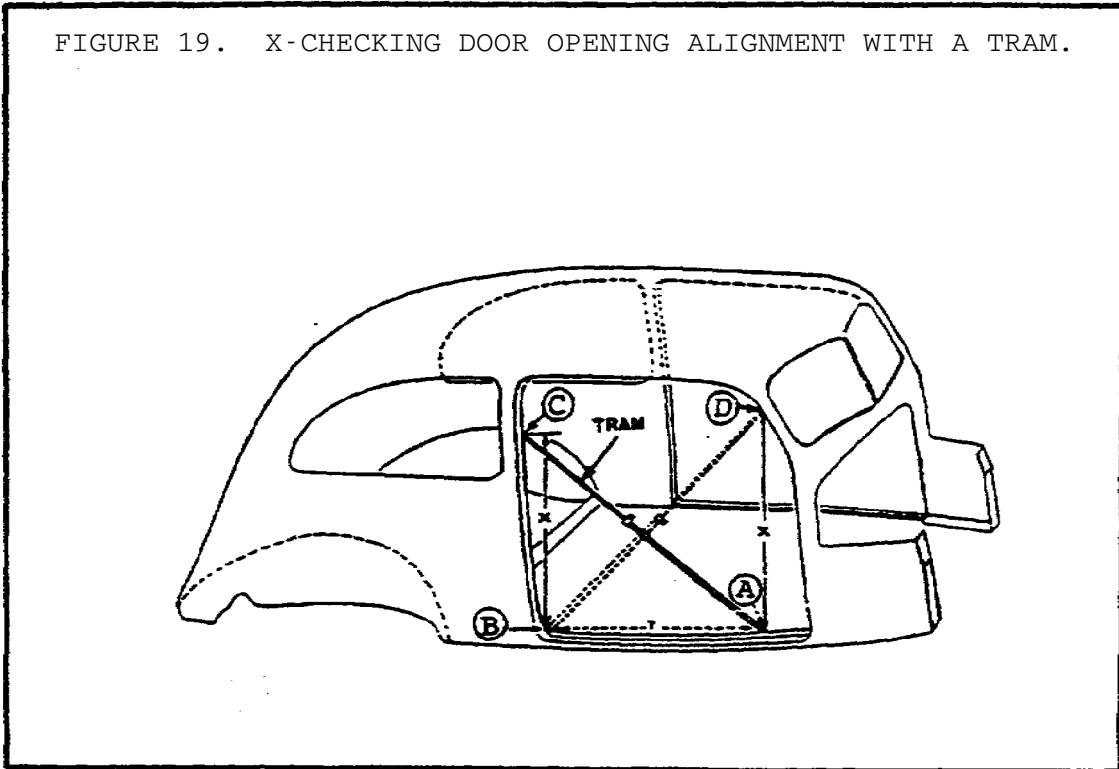
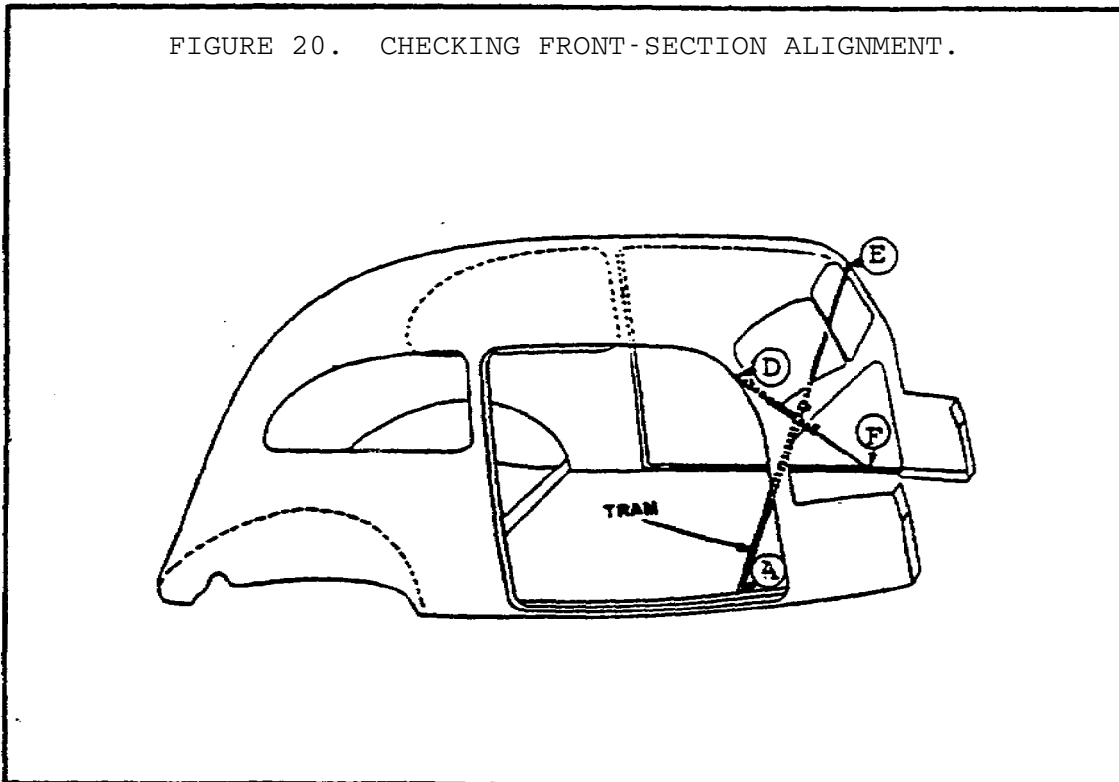
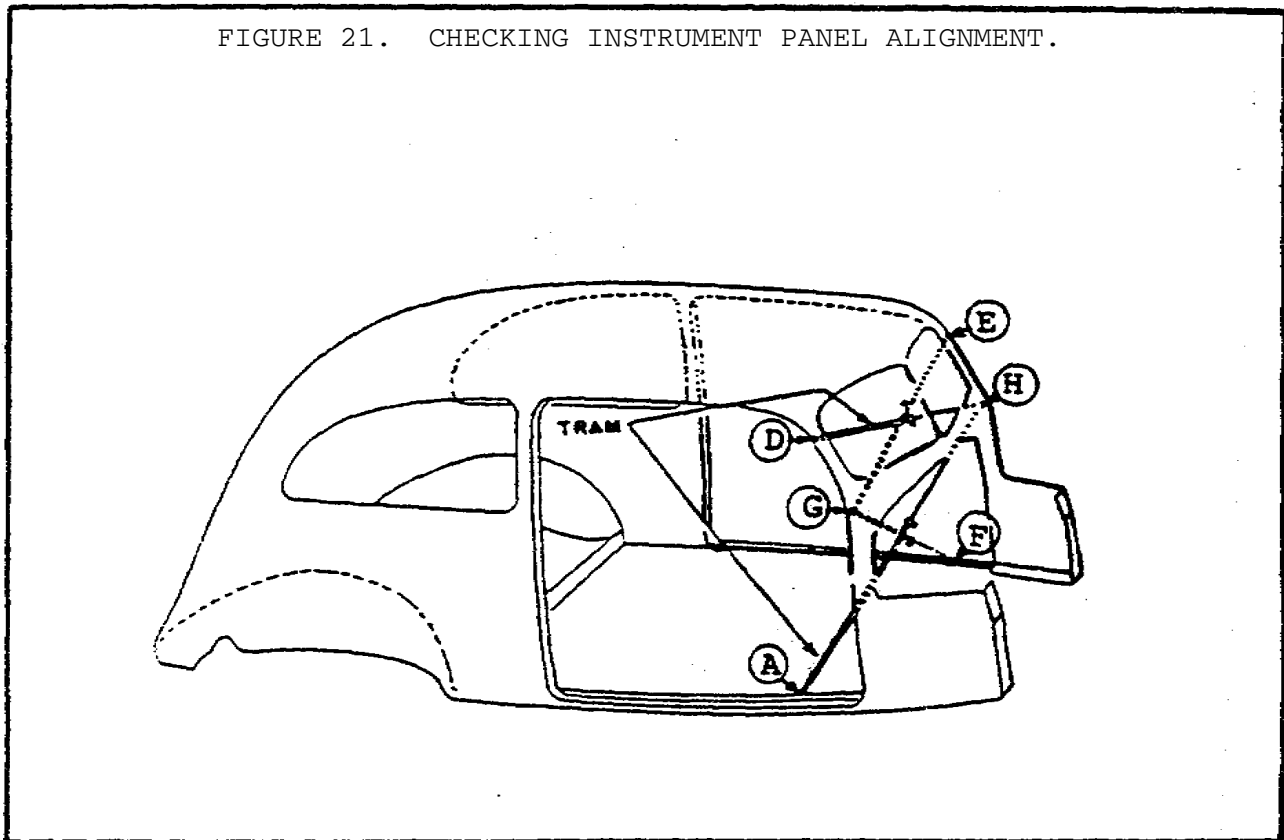

FIGURE 20. CHECKING FRONT-SECTION ALIGNMENT.



METAL BODY REPAIR - OD1653 - LESSON 1/TASK 1

(19) Because the front section is logically divided into two rectangles, one above the instrument panel and one below, each of these should next be tested separately to determine whether the instrument panel is in line (figure 21). This time, points G and E are located at corresponding top-hinge bolt heads on the opposite cowl hinge pillars. The test is now made just as before with the tram, which this time should show diagonals E G and D H to be equal, and G F and A H to be equal.



(20) The center section is tested twice. First points I and J (figure 22 on the following page) are located on the opposite door corresponding to points C and B of the door opening test. The diagonals B I and C J must be equal. Then points K and L are located at corresponding locations in the middle of the center pillar, such as the pressed molding in the body panel. If the tram shows B L and J K to be equal, center alignment is satisfactory.

FIGURE 22. CHECKING CENTER-SECTION ALIGNMENT.

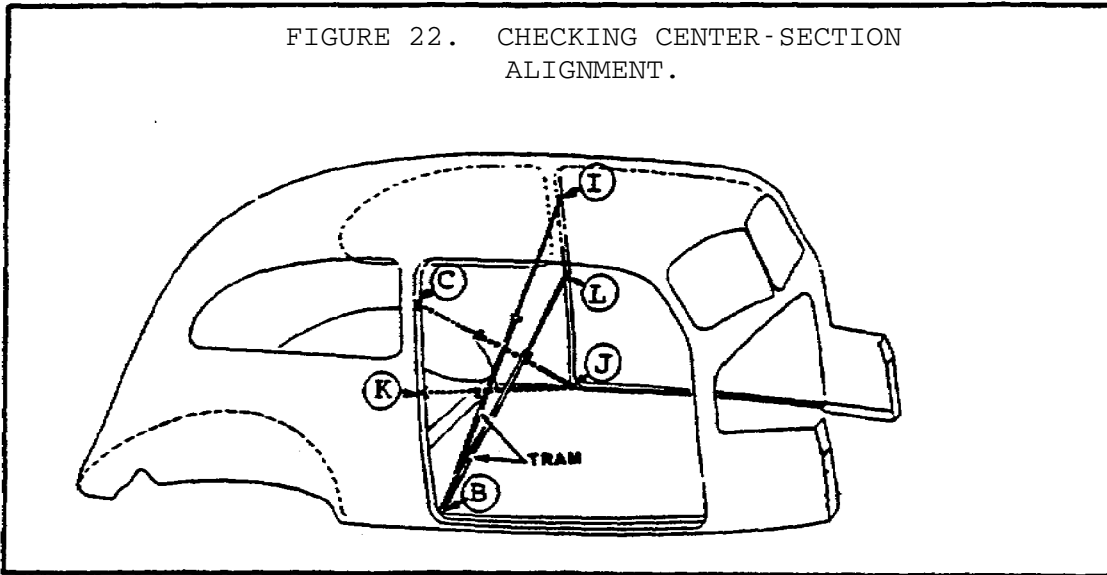

(21) The last test to be made in a coach-style body is a check of the front section against the center section (figure 23). For this test, no new points need be located; the tram is merely used to compare measurement A I and C F and B E against D J.

FIGURE 23. CHECKING ALIGNMENT OF THE FRONT SECTION AGAINST THE CENTER SECTION.

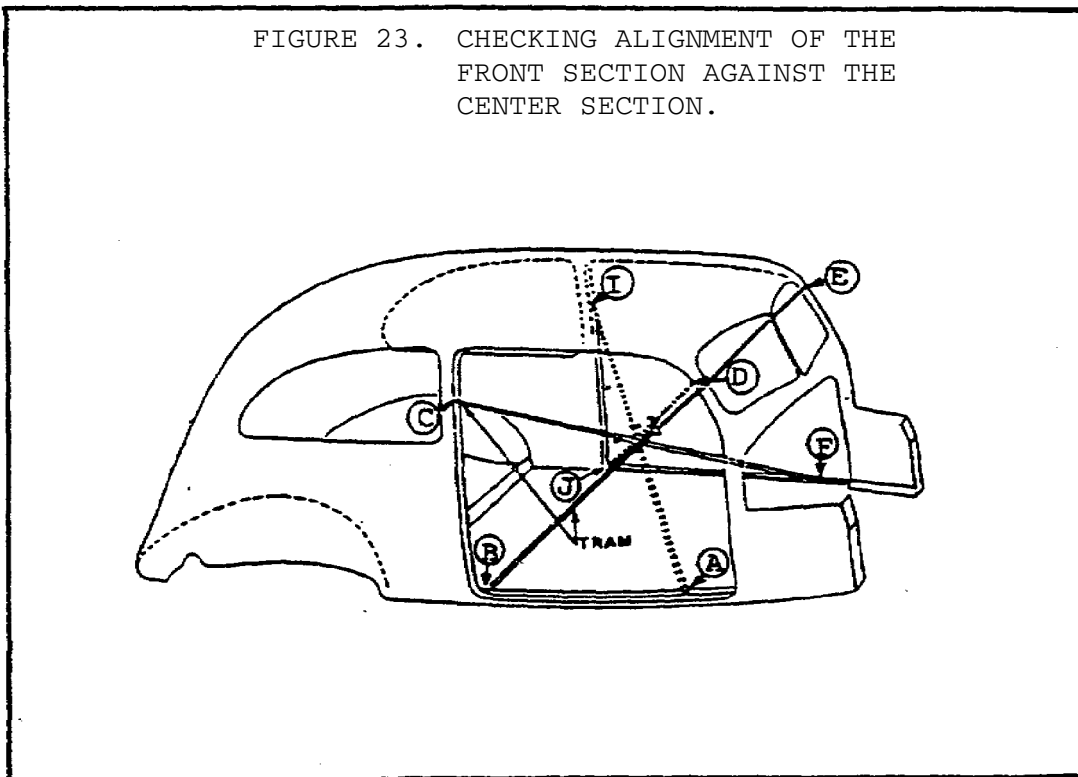

METAL BODY REPAIR - OD1653 - LESSON 1/TASK 1

(22) To correct collision damage in a motor vehicle, it requires a strong force opposite to the direction of the impact. Powerful portable jacks have been developed to replace crowbars, planks and other makeshifts that were used for years to force damaged frames and bodies back into shape. The portable hydraulic jack shown in figure 24 is capable of exerting a 10 ton force. It consists simply of a hydraulic cylinder connected to a hand pump through a hose. It is provided with attachments for pushing, pulling, bending, clamping, or spreading, which can be used singly or in combinations.

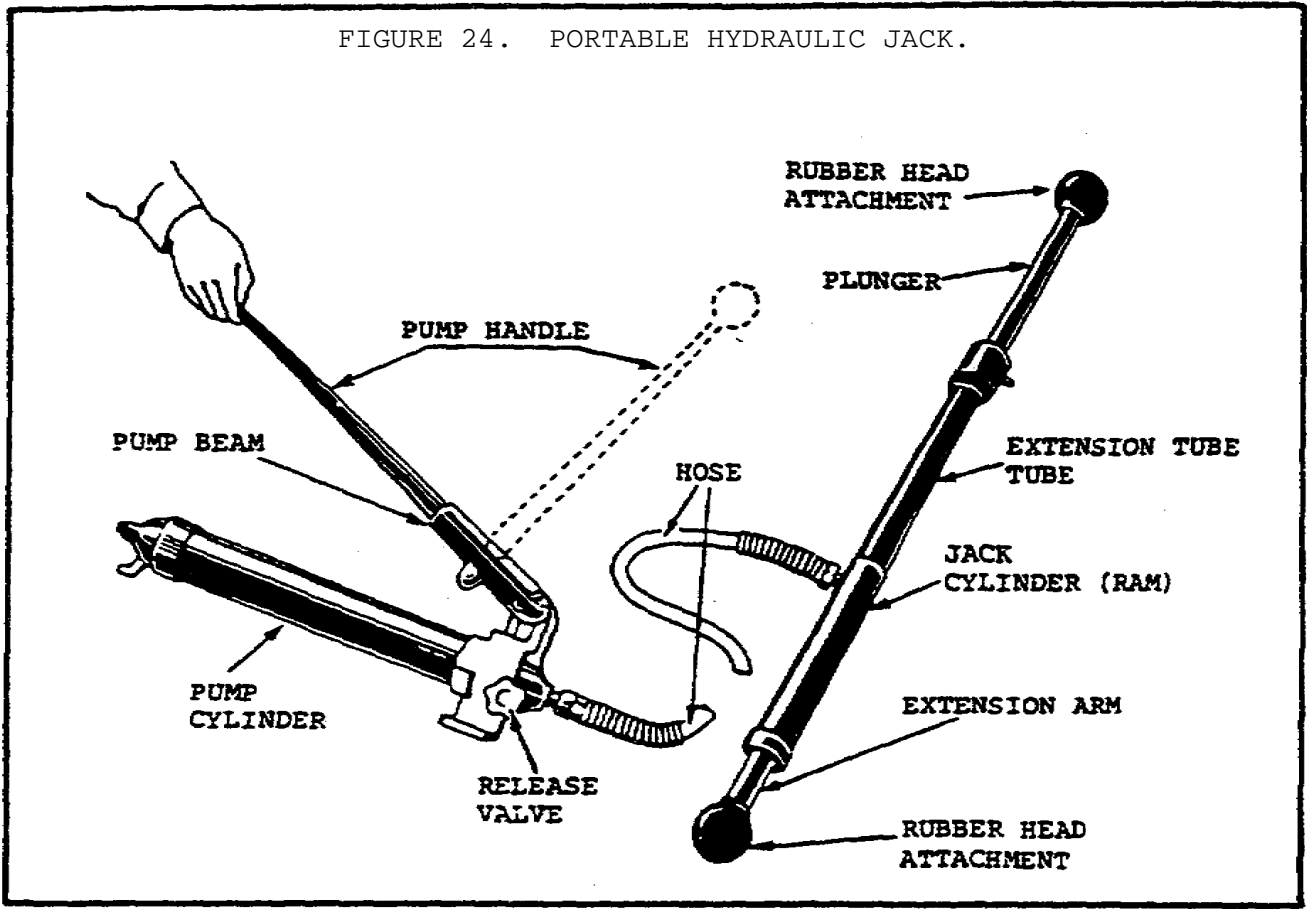

Before using the jack, size up the job to determine the direction of the damaging force. If the frame has been twisted, align this first, removing the body if necessary. Make a setup using the ram and its attachments to apply hydraulic force, reversing the force of the damaging impact.

To operate the jack, insert the handle into the pump beam either horizontally or vertically. Close the release valve, turning it by hand as far as possible to the right. The downstroke of the

METAL BODY REPAIR - OD1653 - LESSON 1/TASK 1

handle forces oil through the hose to the ram, causing the plunger to travel outward under pressure. To release the pressure, turn the release valve on the side of the pump to the left.

d. *Hammer Finishing.*

When a fender or body panel is formed, the shape of the die is transferred to the sheet metal. Later, if the panel becomes bent, creases in the panel tend to hold it out of shape. Nevertheless, most stresses transferred to the metal when it was formed on the body are still in the panel. When the stress of the crease is relieved, the panel will return to its original shape by itself. Since the metal will try to return to its original contour of its own accord, it must be determined what is preventing it from returning. Usually, it will be found that a crease has been formed by impact. This crease may exist in the panel, or it may be found that a crease in the inner construction is preventing the panel from returning to its original contour. If the metal is hammered excessively, it will become stretched. For this reason, it is important that each job be approached with the idea of relieving the strain that is holding the damaged area out of position. Light hammer blows will not displace the metal as much as heavy blows. Several well placed light blows are more effective than one or two hard blows. Each well directed blow of exactly the right force is an effort toward permitting the metal to attain its original contour. Each misplaced blow, or a blow harder than required, may create additional damage which must be corrected.

(1) *Direct Hammering.*

(a) Small pimples may be removed by direct hammering. Figure 25 and 26 (on the following page) show how the dolly block is held for this operation, as well as the relationship of the hammer to the dolly.

(b) Before using the dolly and hammer together, it will be necessary to clean the underside of that portion of the fender on which work will be performed. Body panels and some fenders may be covered with sound-deadening material (undercoat) that must be removed prior to dinging. Deadening material may be pads or mats of a felt material glued in place, or heavy, tar-like, black material

METAL BODY REPAIR - OD1653 - LESSON 1/TASK 1

that has been applied in a semifluid state. This material may have been brushed or sprayed on the panel and later dried. In addition, the underside of fenders, hoods, or bodies may be undercoated. This deadening material must be cleaned from the metal before working with the hammer and dolly.

FIGURE 25. HOLDING DOLLY CORRECTLY WHEN HAMMERING DIRECTLY.

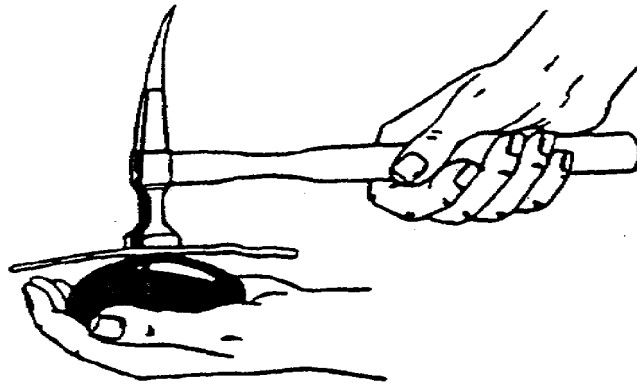
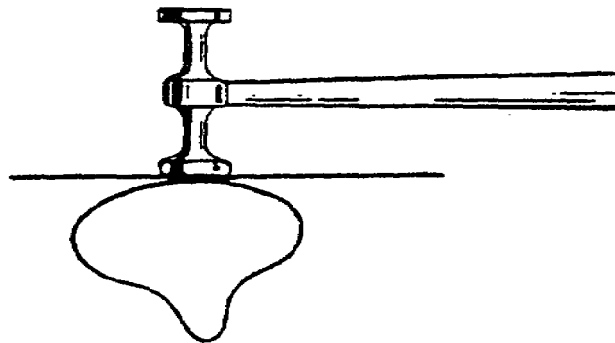

FIGURE 26. POSITIONS OF HAMMER AND DOLLY WHEN DIRECT HAMMERING.



METAL BODY REPAIR - OD1653 - LESSON 1/TASK 1

(c) In direct hammering, the displaced metal will be pushed back to its original contour, by using a dolly that matches the original contour under the damage and striking the damage with a hammer. The dolly provides support and prevents the undamaged areas from being pushed out of place. If the metal is not struck squarely over the dolly, the metal will have no support, creating damage which later must be corrected.

(d) Start by using light blows that show if the metal is being struck squarely over the dolly block. Let the dolly lay in the hand and grip the hammer loosely. When the first pimple has been eliminated, move to the next one, until all have been removed. Two things occur with each hammer blow:

1 The hammer bounds of its own accord, making it ready for the next stroke.

2 The hammer blow on top will drive the dolly block away from the fender; the normal resiliency of the arm will bring it back, striking a blow on the metal from underneath. These actions occur normally only if the hammer and dolly block are held loosely. The importance of this springback of the dolly becomes apparent as shown in indirect hammering.

(2) *Indirect Hammering.*

(a) Metal that has not been excessively hammered, displaced, or stretched will have a tendency to return to its original contour of its own accord. This is due to the internal stress imparted to the metal by the forming dies. If the metal is prevented from springing back by other strains imparted to it by additional bends or creases, the metal is restored to normal contour by relieving whatever new stress is holding it out of position.

(b) In bumping or dinging, this is accomplished by relieving the stress with indirect hammering. Figure 27 (on the following page) illustrates a cross section of a damaged area in which sharp creases have been formed all around an area and another sharp crease has been formed in the low spot of the damaged area. The procedure employed in indirect hammering is to hold a dolly having the correct contour to match the original contour of

FIGURE 27. POSITION OF THE DOLLY WHEN INDIRECT HAMMERING.

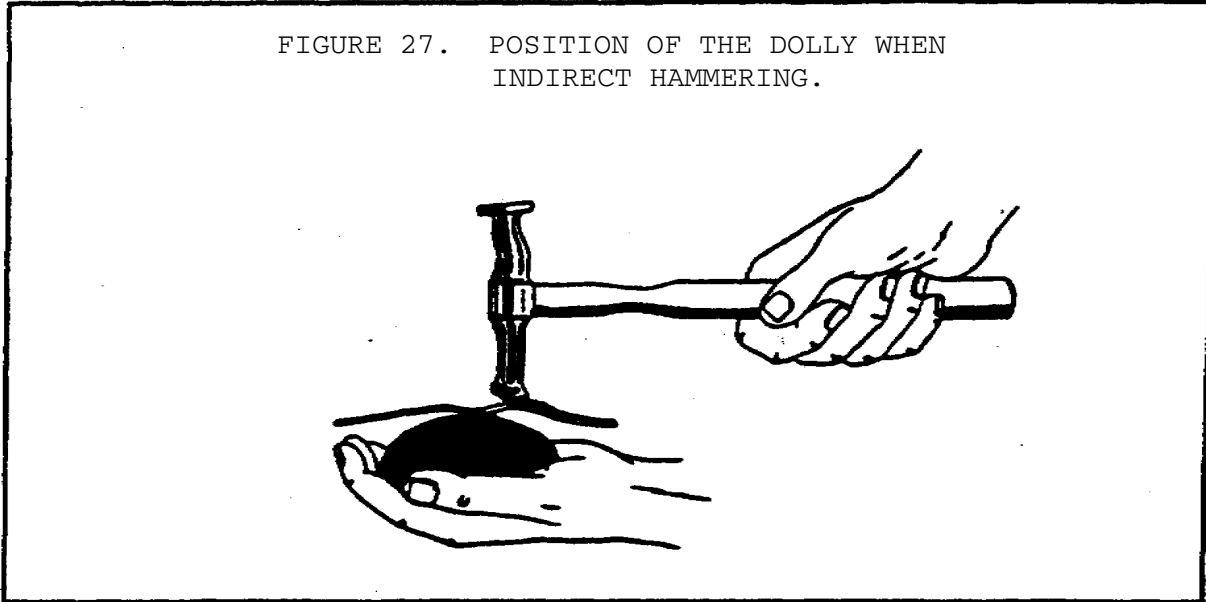

the metal at the low spot, and to strike a series of light blows around the outer creases.

(c) The corrective action is as follows:

1 A light blow will not displace the surrounding undamaged area, but the force of the blow will be transferred to the dolly block. In effect, this pushes the bent portion downward and straightens it.

2 As a result of receiving the hammer blow indirectly, the dolly block will be pushed away from the low part of the damage. However, it impacts a light push upward on this area. Knocked away from the fender, the workman's hand will automatically bring it back in place, imparting a second light blow to the area. As work progresses, using light hammer blows around the outer edge of the damage, the center of the damaged area slowly rises until the original contour is restored.

(3) *Spring Hammering.*

(a) When a crown is formed in metal, it becomes strong and resists any change to its shape. It can be compared to an arch used in the construction of a building or bridge. The strength of this arch or crown can, in many instances, be used to support the surface being hammered without the use of a dolly. This is called spring hammering.

(b) Creases in metal, at points where it is impossible to back up the hammer with a dolly block, can often be corrected by this method. To take advantage of a greater amount of the natural support provided by the crown of the metal, the force of the hammer blow is spread over a large area with a spoon. The spoon is placed lengthwise over the ridge of the crease or other high spot and struck a series of light blows with the hammer until the unwanted stress is relieved and the raised portion is back to its original shape or position.

FIGURE 28. SPRING HAMMERING USING A SPOON.

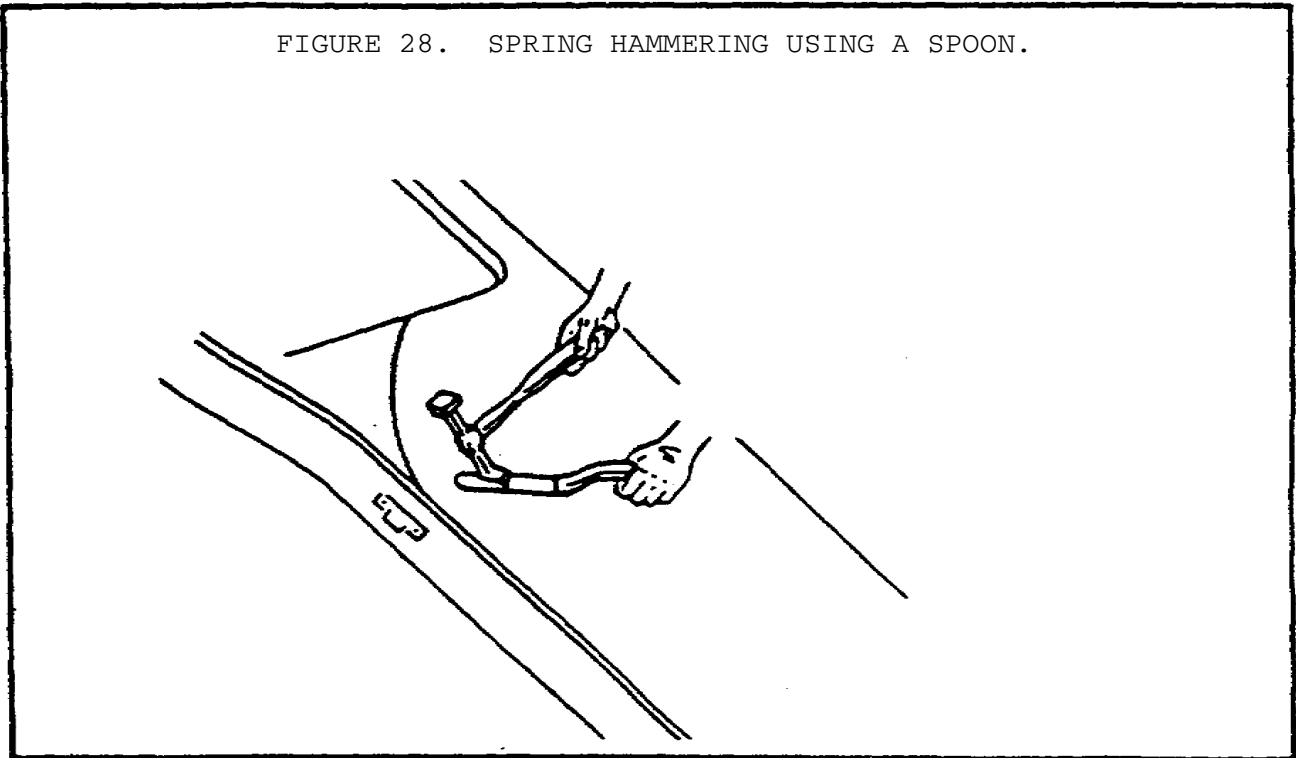

(c) In this method of hammering, no hammer marks are formed on the metal since all of the blows are on the spoon rather than on the metal (figure 28). Once the metal is back to its original crown, additional hammering will cause the surface to sink below its original contour line, and it may not be brought back readily. Always start with light blows and, as the job nears completion, inspect the contour after each blow. This will reduce the possibility of sinking the hammered surface too low.

(4) *Pick Hammering.* Pick hammering is one of the most difficult jobs to master. You will need a lot of practice before you can make competent use of this tool.

METAL BODY REPAIR - OD1653 - LESSON 1/TASK 1

(a) A pick hammer is used to bring up low spots, particularly in areas which have been badly creased or stretched and have lost their tendency to return to their normal contour. Figure 29 illustrates examples of pick hammering employed to raise low spots. As a rule, the pick hammer, working from the underside of the metal, is used to hit the center of low spots three-eighths of an inch or less in diameter.

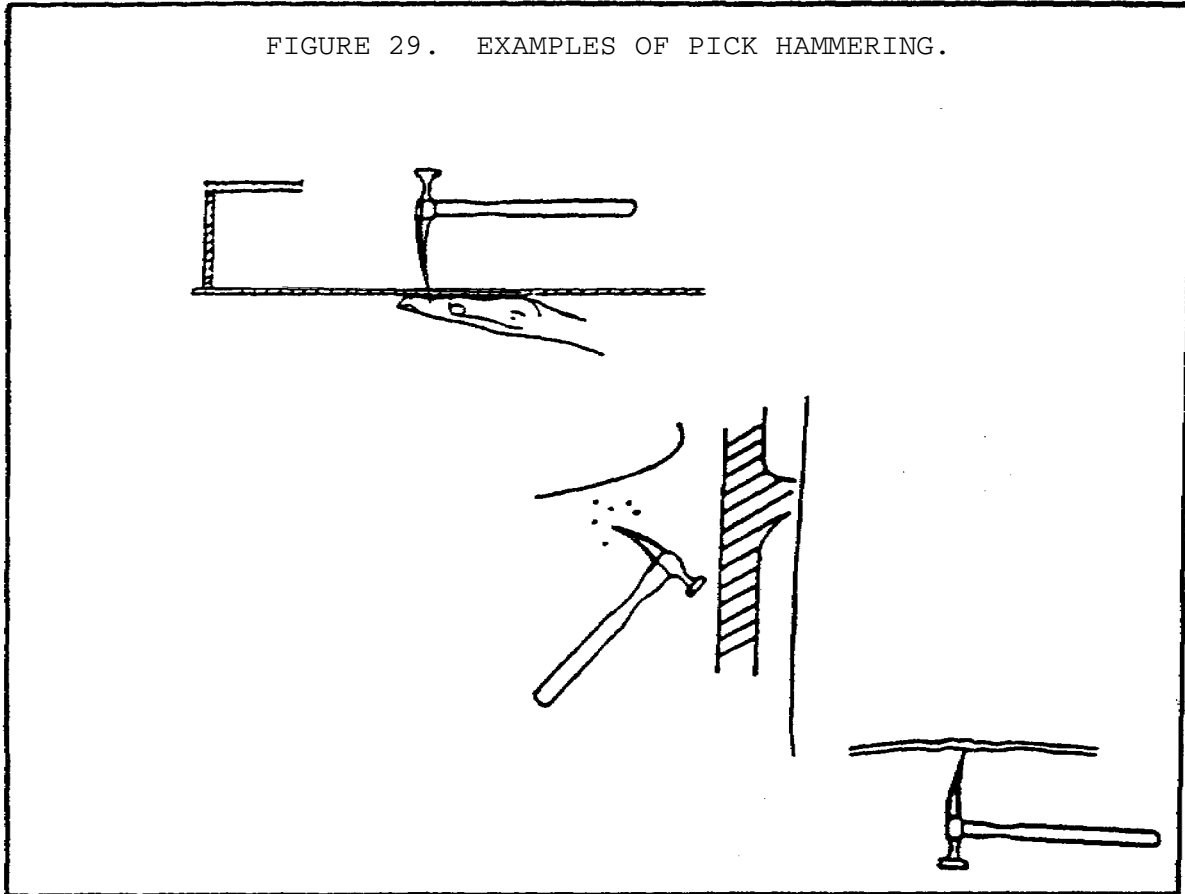

(b) The pick, being sharp, stretches the metal and forms a pimple on the surface. At the same time the pimple is formed, the metal immediately surrounding it, though not displaced or stretched, is raised. It is obvious that accuracy in the use of the pick hammer is of the utmost importance.

e. *Metal Shrinking.*

(1) *General.* When body panels and fenders are formed in dies under high pressure, the sheet metal is stretched and drawn, then compressed. This

displaces the molecules of metal. The high pressure of the press squeezing the metal locks the molecules in a new position. They will resist any subsequent force which tries to change their arrangement. Metal has some elasticity; that is, metal can be bent or twisted without permanent disarrangement of the molecules. When the force thus applied is removed, the elasticity of the metal will cause it to resume the shape that it had when the molecules of the metal were locked together in the dies. The body repairman must avoid destroying this natural tendency of the metal to return to its original shape. This is not always possible in collisions where the normally smooth surface is badly creased. Creases represent a portion of the metal that has been distorted beyond its elastic limit and in which the molecules have been displaced. They are no longer locked together in the same arrangement that was given to them in the forming die.

(2) *Hot Shrinking.*

(a) Hot shrinking is a simple process, but it requires careful timing and proper tools. Tools required are those which are used for many other operations in body work; i.e., a welding torch that is equipped with the same size tip as used for welding the thickness of sheet metal being worked on; a body hammer or mallet; shrinking dolly; a container of water, and a sponge or rag.

(b) Arrange the tools so they are within easy reach. It is necessary to change quickly from one tool to another when performing shrinking work.

(c) Locate the highest point in the stretched section of the panel with which you are working. Light the torch and heat a spot the size of a nickel in the center of the high spot (A) (figure 30 on the following page) to a bright red. Use a circular motion when heating the spot, being careful not to burn through the metal. As soon as the spot is bright red, place the shrinking dolly under the spot and strike it several sharp blows with a hammer or mallet (B).

(d) After driving the center down, hold the dolly block loosely against the underside of the panel and exactly centered under the hotspot. The hammer blow must hit the spot accurately and with sufficient force to push the metal down while it

METAL BODY REPAIR - OD1653 - LESSON 1/TASK 1

is still hot. After four or five hammer blows, the heated spot will turn black. Quench it immediately with water and a rag or sponge. Quenching with water will complete the shrinking operation. Repeat this operation, taking the next highest spot in the stretched section of the panel, using the sequence shown in figure 31.

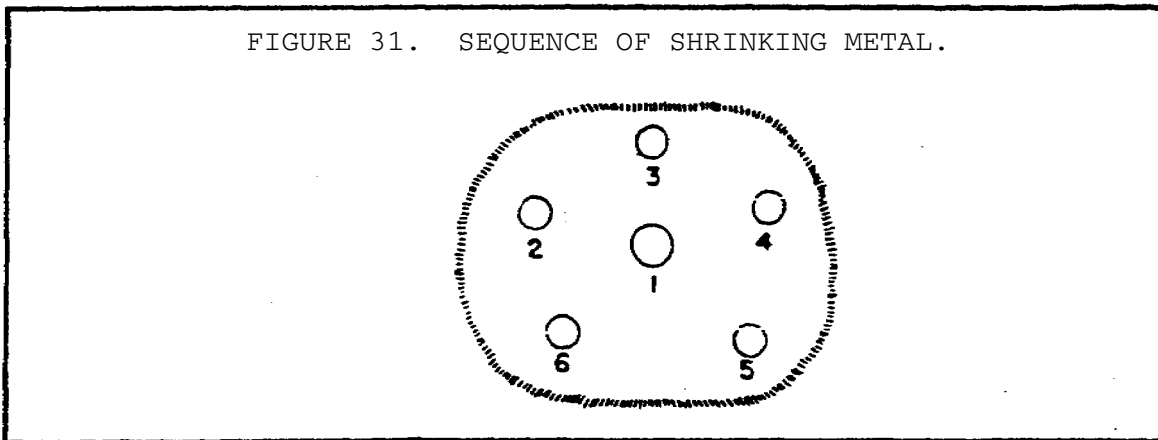
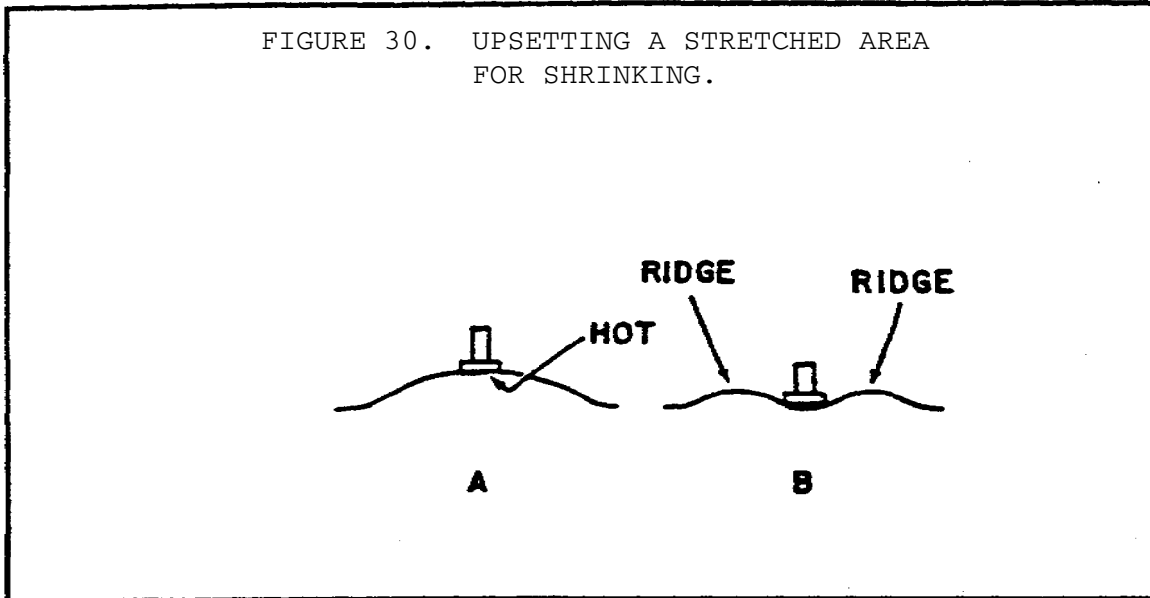

(e) In case of a long narrow stretch caused by a sharp object rubbing across the surface, start at one end and heat a spot to a bright red, three inches long, in the bottom of the crease. While the spot is bright red, use a body hammer to raise the metal above the surface of the panel. Repeat

METAL BODY REPAIR - OD1653 - LESSON 1/TASK 1

the above operation until the entire crease has been raised, then shrink following the procedure as explained above.

(f) When performing a shrinking operation, exercise care to avoid overshrinking the panel. This will cause the metal to warp and buckle both in and out of the stretched area. However, if this condition does arise, heat a small spot in the area where the panel is buckling, apply a dolly block or spoon with enough pressure to hold the buckling section up, and allow the metal to cool. Do not use the hammer or water in this instance. In extreme cases, it may become necessary to repeat this operation in several different places in the warped area.

(g) Aluminum shrinking follows the same general procedure as steel. Care must be used to avoid burning through the metal at point of contact with the flame because this metal absorbs heat much more rapidly than steel and does not change color under heat. Care must be taken when using water as a quenching media because there is a chance the metal will crack when cooled too quickly. Just as soon as the metal starts to blister where the flame contacts the metal, the flames must be removed, and hammering done quickly with a wooden or fiber mallet.

(h) Certain rules should be observed at all times during shrinking operations. They are:

1 Never quench a red hotspot. Wait until the metal has turned black.

2 Never heat an area greater than that where pressure can be applied at one time with the hammer and dolly.

3 Never use anything but an acetylene torch for heating a stretched section.

4 Never attempt to shrink a panel until it has been roughed out.

5 Never apply heat to a low spot for shrinking. Hammer it out, then apply the beat.

6 If the stretched part of the surface is small, heat a smaller spot.

METAL BODY REPAIR - OD1653 - LESSON 1/TASK 1

7 It is possible to shrink metal without quenching each spot with water. However, the shrinking operation is much faster if each spot is quenched with water. Less heat spots are required if the heat expansion is drawn out by quenching, rather than by additional spots.

(3) *Cold Shrinking.*

(a) The shrinking dolly is formed so that two sides of it have a low crown radius, with the two ends being concave.

(b) The hammer used is the offset crosspeen. The hammer is similar to other hammers except that one end of the head is shaped to exactly fit the concave contour of the shrinking dolly.

(c) After a weld has been made, it sometimes becomes necessary to sink the weld. The concave portion of the dolly block is placed directly underneath the weld. A blow is then struck with the peen side of the hammer, driving the weld down so that a valley is formed. This depression is made the entire length of the welded joint and later filled with body solder or filler.

(d) To cold shrink a panel, place the shrinking dolly under the high spot and form a concave bead or valley as previously outlined in paragraphs 7e(3)(a) through (c) above. Move the dolly along slowly in a straight line beneath the high spot and strike the outside surface with the hammer.

Do not make the bead any longer or deeper than necessary to draw the stretched metal back to its normal contour. It may be necessary to make an X-shaped bead. The X-shaped valley is made the same way as a single valley except that a second one is made at right angles to the first one.

(e) When shrinking aluminum, it may be better to cold shrink instead of hot shrink. The procedure for cold shrinking aluminum and steel are the same.

f. *Body File.*

(1) A body file is used for many things: to remove paint, smooth metal, find low spots, remove excess solder, quickly remove aluminum, and to form the correct contour of areas that have been built

up with solder. The gage of metal on sedan bodies is as light as practical, and every precaution must be taken not to file or grind away any metal unnecessarily. When removing high spots by grinding or filing, care must be taken not to cut through or weaken the part.

(2) Using the file is a two hand job. One hand is used to hold the file handle (figure 32), the other is used to grasp the file around the saddle at the opposite end of the handle.

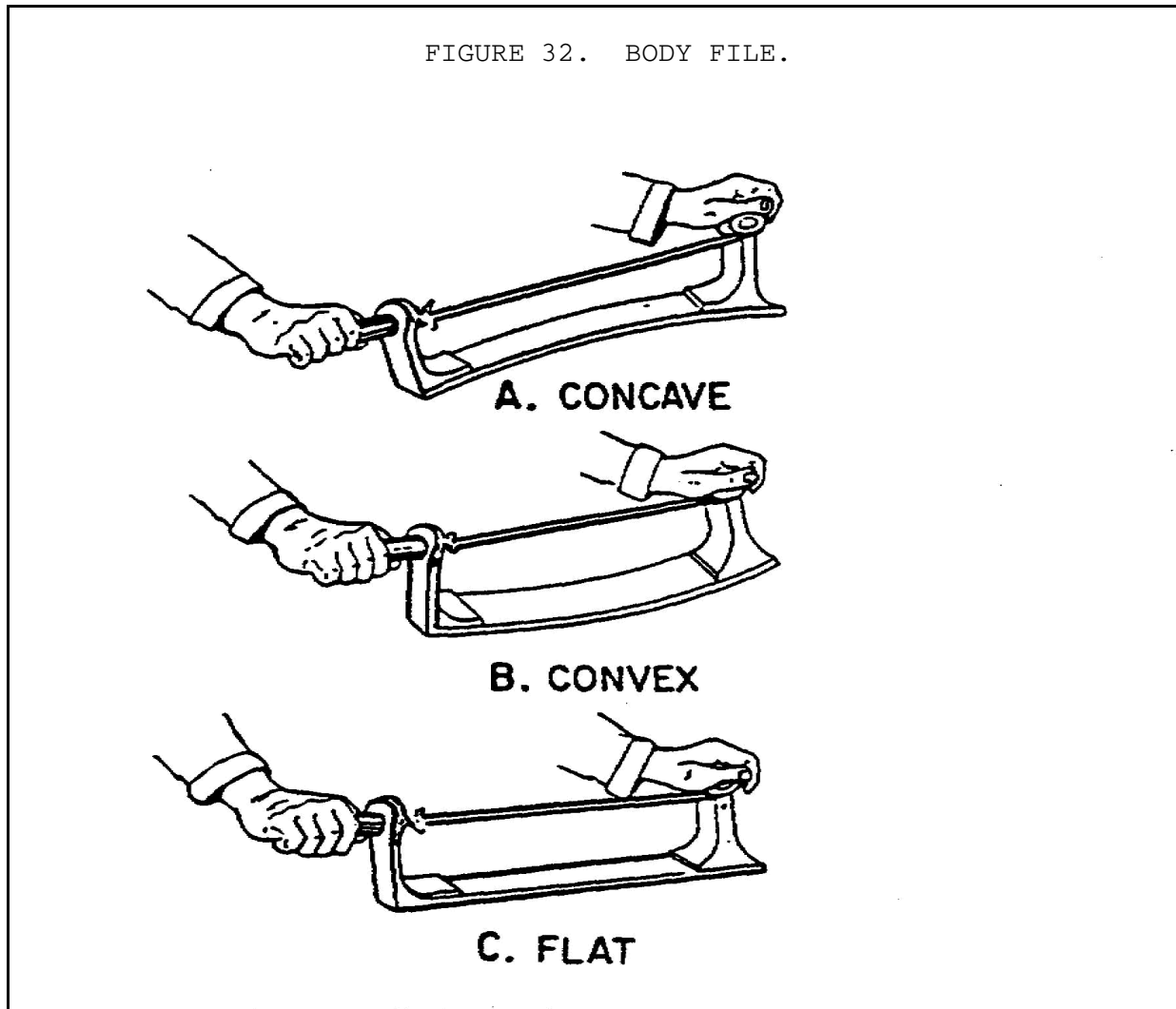

(a) The file blade is fastened to the holder with the cutting edges of the teeth facing away from the handle. Adjust the contour of the file holder so that it almost, but not quite, matches the contour of the surface.

METAL BODY REPAIR - OD1653 - LESSON 1/TASK 1

(b) Place the file on the work. With a straight stroke, push the file away from you, holding it at an angle of 30 degrees in relation to its line of travel. If the file digs in, you are putting too much pressure on it. At the end of the first stroke, raise the file and bring it back to where you started and make a second stroke. Remember to raise the file at the end of each stroke. It should not be pulled back over the metal because dragging will tend to dull the file blade.

(c) By filing in the above manner, the file marks are parallel and have removed all of the paint, and probably some of the metal, from the work in the filed area. This type of filing is referred to as line filing. The term "line filing" means all the strokes, and consequently, all of the file marks, are in the same direction.

(d) Now change the direction of your file strokes so they are about a 45 degree angle from the previous direction. This is referred to as X-filing. When the file is moved so that you are X-filing, you may find that the contour of the area differs slightly. If this is true, adjust the file holder again to nearly, but not quite, match the contour. Then go over the entire area once lightly. You will now find that the new file marks cross the original file marks at a 45 degree angle and that these two sets of file marks form a series of innumerable X's from which the term "X-filing" is derived. X-filing or cross-filing is necessary to establish or maintain a contour that curves in more than one direction; whereas, line filing is used on more simple surfaces. When filing, it is always a good plan to make a few cross or X-strokes occasionally to make sure that you are not destroying a secondary contour in the metal. This is particularly important when filing areas that have been built up with solder or other material.

(3) When using body files on epoxy fillers, ensure that the fillers are thoroughly cured or the file will clog and gouge the surface.

8. Conclusion

Knowledge of the metal body repair procedures described in this subcourse task should provide a strong basis for being able to perform repair on

METAL BODY REPAIR - OD1653 - LESSON 1/TASK 1

the various vehicles and trucks in the U.S. Army inventory. Most of the repair procedures for collision work involve removal and installation of various body parts, panels, and accessories. Some require complete disassembly before repair can properly be performed. As previously stated, without a clear understanding of the basics of automobile construction and assembly it is very difficult to follow correct repair procedures. In the next lesson, you will learn the specific repair procedures for repairing glass, radiators, and fuel tanks.

METAL BODY REPAIR - OD1653 - LESSON 1/PE 1

PRACTICAL EXERCISE 1

1. Instructions

Read the scenario and respond to the requirements that follow the scenario.

2. Scenario

You have been assigned to an Intermediate Direct Support (IDS) unit just outside Frankfurt, Germany. For one of your functions in this unit, you serve as the officer-in-charge of the service section.

A report of survey has just been completed on a military sedan that was involved in a collision. Due to a shortage of vehicles within this particular user unit, the decision was made to repair the automobile instead of applying code-H to the vehicle.

Though you are in the process of receiving additional body repairmen, you find out that these men are from a reserve unit. Before assigning any of the reservists to work on the damaged sedan, you decide to test them on various operations required to repair a damaged vehicle.

3. First Requirement

Using your knowledge of metal body repair and this subcourse, prepare an answer sheet for the questions listed below regarding the procedures required to repair damaged vehicles.

- a. Why do passenger car and truck bodies differ in construction?
- b. What body panel assembly is usually the largest vehicle panel, and also the simplest in construction?
- c. What is a deck lid commonly called?
- d. What stocks are automotive frames usually constructed from?
- e. What are the two most common tools used to remove paint, rust, and undercoating?

METAL BODY REPAIR - OD1653 - LESSON 1/PE 1

- f. Describe a "drop" frame.
- g. Is it economical to repair a body which has sustained damage to the main structural members severe enough to collapse the box section member?
- h. What item is NOT recommended as an aid in straightening crossmembers: C-clamps, heat, hydraulic jack, or attachments.
- i. What is the primary reason rivets are used to connect separate parts of automobile and truck frames?
- j. What vehicle hardware is normally referred to as trim?
- k. Weatherstripping is normally used to secure windshield glass within the roof panel assembly. How are the windshields of combat-type vehicles held in place?
- l. A dinging hammer is a general purpose hammer principally used on what automotive panel?
- m. Name the hammer that is used to raise small, low spots when crossfiling.
- n. Describe the shape of a roughing hammer.
- o. What alloy is the high crown dolly made from?
- p. On what parts of the vehicle will the hooks on the low crown dolly normally be used?
- q. What tool is used for removing dents on quarter panels around rear pillars, behind inner construction, and behind back panel strainers?
- r. What is another name for a caulking iron?
- s. Name the two types of hydraulic body jacks.
- t. What hydraulic jack component gives 6 inches of prompt adjustment when pushing out large areas.
- u. Five different minerals are commonly used for manufacturing abrasives used with sanding disks. Name these abrasives.
- v. Name the body shop applications for using a close coat No. 36 sanding disk.

METAL BODY REPAIR - OD1653 - LESSON 1/PR 1

- w. What sanding disk is used to remove scratches left by No. 24 and No. 36 sanding disks?
- x. Restoring vehicle body panels of sheet metal to their normal contour after they have been damaged is normally referred to as what?
- y. When using a dolly, what is lost if it is gripped tightly or held against the body panel with a great amount of pressure?
- z. What is the measuring device which is a telescoping tube equipped with an extension clamp which fixes it as the measurement of one diagonal is made for comparison with another?
- aa. When the stress of a crease in a body panel is relieved, is it normal for the panel to return to its original shape by itself?
- bb. When hammer finishing, are several well placed light blows more effective than one or two hard blows?
- cc. Before using a dolly and hammer together to correct damage to a fender, what must be done first?
- dd. Name the tools normally used when performing hot shrinking of metal.
- ee. Aluminum shrinking follows the same general procedures as steel. However, care must be exercised to avoid burning through the aluminum. Why is it easier to burn through aluminum than steel?
- ff. As a general rule, a red hotspot should not be quenched. When is it safe to quench a hot spot?
- gg. As a general rule, is it correct to apply heat to a low spot for shrinking?
- hh. Name the hammer that is most often used when performing cold shrinking operations.
- ii. When shrinking aluminum, which is the better process: cold shrinking or hot shrinking?
- jj. When using body files on epoxy fillers, why is it necessary to ensure that they are thoroughly cured?

METAL BODY REPAIR - OD1653 - LESSON 1/PE 1

kk. What is the purpose of tinning a metal surface?

ll. Before a solder paddle is applied to hot solder, it should be covered with what to prevent the hot solder from sticking to it?

mm. When using 30/70 solder in a paddle soldering operation, what do these numbers represent?

METAL BODY REPAIR - OD1653 - LESSON 1/PE 1

LESSON 1. PRACTICAL EXERCISE - ANSWERS

1. First Requirement
 - a. The purpose that each is intended to be used for is different.
 - b. The roof panel assembly.
 - c. Trunk.
 - d.
 - (1) Channel stock
 - (2) Angle
 - (3) T-stock
 - (4) Z-stock
 - (5) Tubing
 - (6) I-beam
 - (7) Flat plates
 - (8) A combination of any two or more of the above stocks
 - e.
 - (1) Wire brush
 - (2) Grinding wheel
 - f. The main part or center of the frame is dropped down between the front and rear wheels.
 - g. No.
 - h. Beat.
 - i. Rivets are used because of their structural strength and their ability to give with the road condition.
 - j.
 - (1) Moldings
 - (2) Floor mats
 - (3) Armrests
 - (4) Head linings
 - (5) Door trim pads
 - (6) Weather stripping
 - k. Combat type vehicle windshields are held together by a metal frame and sheet metal and machine screws, and are attached to the body by hinges and brackets.
 - l. Body panels.
 - m. Pick hammer.

- n. A curved shank with a round face.
- o. Forged alloy steel.
- p. (1) Fender beads
(2) Drip moldings
(3) Sharp, concaved moldings
- q. Double end and lower back quarter panel spoon.
- r. Fender beading tool.
- s. (1) Direct acting jack
(2) Remote controlled jack
- t. Slip lock extension.
- u. (1) Garnet
(2) Flint
(3) Emery
(4) Aluminum oxide
(5) Silicon carbide
- v. (1) Removing welds
(2) Revealing high and low spots in bumping operations
- w. Close coat No. 50.
- x. Metal bumping or dinging.
- y. Automatic bounce and rebound of the dolly.
- z. The tram.
- aa. Yes.
- bb. Yes.
- cc. The underside portion of the fender being worked on must first be cleaned.
- dd. (1) Welding torch
(2) A body hammer or mallet
(3) Shrinking dolly
(4) Container of water
(5) Rag or sponge
- ee. Aluminum absorbs heat far more rapidly then steel and does not change color under heat.
- ff. When the metal hotspot has turned black.

METAL BODY REPAIR - OD1653 - LESSON 1/PE 1

- gg. No. It should be hammered out before heat is applied.
- hh. Offset crosspeen.
- ii. Cold shrinking.
- jj. If the epoxy has not thoroughly cured, the body file will clog and gouge the surface being worked on.
- kk. The process of tinning prepares a surface for receiving and holding solder.
- ll. A light coat of oil.
- mm. Solder composed of 30 percent tin and 70 percent lead.

METAL BODY REPAIR - OD1653 - LESSON 2/TASK 1

LESSON 2

OPERATIONS REQUIRED FOR
GLASS, RADIATOR, AND FUEL TANK REPAIR

TASK 1. Describe the operations required for proper glass repair.

CONDITIONS

Within a self-study environment and given the subcourse text, without assistance.

STANDARDS

Within one hour

REFERENCES

No supplementary references are needed for this task.

1. Introduction

The many glass sections found in modern vehicles are meant to give the driver and passengers a clear view of the traffic and surroundings. It is hazardous to drive a vehicle which has cracked or fogged glass. Broken or faulty glass not only obstructs visibility, but sudden fragmentation may cause serious injury to the car's occupants. Cracked and broken glass sections are very common, and the auto body technician will encounter replacement jobs often.

The glass used in automobiles differs greatly from conventional types of glass. Automotive glass must furnish clear, undistorted visibility as well as meet certain safety standards. The visibility feature of auto glass refers to freedom from distortion. The glass must furnish a clear and unobstructed view from all angles. Making such glass requires special technology and very close tolerances. The early automobiles did not have such glass, and poor visibility was often a cause of accidents.

METAL BODY REPAIR - OD1653 - LESSON 2/TASK 1

2. Glass - Composition and Characteristics

Glass at ordinary temperatures is rigid, not easily corroded except by hydrofluoric acid, and is comparatively resistant to abrasion. Like wax, it becomes softer and more pliable as the temperature rises. Salt water has a chemical or abrasive action on glass that causes a frosted appearance after sufficient exposure. It is only slightly porous and, therefore, easily cleaned. Glass is not entirely colorless. The ability of glass to transmit light and offer protection against air, water, and dust makes glass one of the most important automotive materials. Glass is only slightly less strong than some grades of cast iron. But, it is far more brittle, and any external force will set up stresses within it that will be retained for some time. Any force added to these retained stresses may cause a break. This property is a great aid in cutting sheet glass. Glass is made by combining a silicate such as common sand, and alkali such as sodium carbonate, and either lead or lime. It is commonly classified as lead glass or lime glass.

a. *Lead Glass.* This glass has the higher luster but is more brittle and more easily scratched. It is used principally for optical and decorative purposes.

b. *Lime Glass.* Only lime glass is used for automotive work. Because the available supply of silicate, alkali, and lead or lime is not usually pure or readily usable, carbon, arsenic or other substances must be added to purify them and assist them in combining. Substances such as iron, copper, or chromium may also be added to change the color, hardness, or other properties. These solid components, melted together, form liquid glass. When its impurities rise to the surface, the molten glass is drawn off and allowed to harden. A sheet of glass is generally a large, flat piece having no particular shape. When the term is applied to laminated glass, it means one of the layers. Laminated glass is sold in cut, rectangular sheets from 4 by 18 to 24 by 56 inches, called blocks. About 50 square feet, weighing approximately 200 pounds, are ordinarily packed together and are known as a box.

c. *Types of Glass.*

(1) *Plate Glass.* Plate glass is poured on a flat heated surface, cooled until it becomes plastic, and then rolled to about twice the thickness intended for the finished plate. After rolling, it is slowly cooled or annealed, and when cold it is ground with sand and polished smooth and flat. Modern glassmaking is a continuous process in which glass comes out between rollers in a continuous ribbon. The ribbon is not cut until it is cold and ready for grinding. Grinding and polishing make the surface more porous and less resistant to attack by acids, alkalies, and (of special importance) salt water. It must be handled carefully and kept clean; crayon marks imbedded in its pores cannot be completely removed. Plate glass may be tempered to make it harder and more shock resistant.

(2) *Window Glass.* Window glass is blown or poured into sheets of the desired thickness, then annealed and cut to the desired size. Unlike plate glass, it is never ground or polished. The surface therefore is somewhat less porous than plate glass and more resistant to scratches and salt water, but it is slightly wavy. Like plate glass, it may be tempered. Tests show that plate glass is markedly superior to window glass in motor vehicles for reducing fatigue and eye strain and increasing the ability to judge distance and to read road signs.

(3) *Tempered Glass.* Tempered glass is made by reheating plate or window glass until it is somewhat soft, and cooling it quickly in a bath of hot oil or against a cold metallic surface. It will then withstand heavy impacts and great pressures. However, a comparatively light blow with a pointed object will break it because of the internal stresses caused by the sudden cooling, and it may fly apart violently when broken. Because of these internal stresses, it cannot be cut or ground, but is shaped when soft. Rear windows, particularly curved ones, may be tempered glass.

(4) *Bulletproof Glass.* Bulletproof glass has very limited uses. It is very thick, usually 3/4 inch, and resists bullets. They may, however, chip or crack it. Bulletproof glass and curved glass,

METAL BODY REPAIR - OD1653 - LESSON 2/TASK 1

which are seldom used by the Army, are not ordinarily cut except in shops especially equipped for that purpose.

(5) *Laminated Safety Glass.* Glass that breaks into small, sharp pieces is dangerous to use for windows in motor vehicles. Manufacturers have therefore developed laminated safety glass, which is built up like a sandwich with a sheet of tough plastic material bonded between two sheets of glass. If this glass breaks, the plastic stretches when hit, serving as a cushion and holding the sharp glass fragments firmly. Except for its safety feature, laminated safety glass has the same properties as the glass from which it was made. It is used for replacement of practically all flat glass in Army motor vehicles, such as windows and windshields.

d. *Removal of Vehicle Glass.* When removing broken glass, carelessness can result in cuts from sharp edges or flying particles of glass. By careful removal, the old glass can be used as a pattern for the cutting of new glass for the vehicle. The method of removing glass will vary according to the make and model of the vehicle. All Army combat-type vehicles have windshield and door glass enclosed in protecting metal channels or frames.

(1) Combat-type vehicles (3/4 ton and larger) windshield hinges are composed of a rolled strip attached to the underside of the top of the outer windshield frame and a similar roll on top of the individual metal frame of the windshield. To separate them (when the windshield is open), slide the entire metal frame of the windshield glass sideways off the vehicle. They are reinstalled in the reverse order.

(2) Glass that is installed in channels or frames is removed with a channel vise. The vise has rubber padded jaws to hold the glass securely and an adjustable lever to pull the channel from the glass without cracking or breaking the glass. Careful removal of old glass is the best source of obtaining accurate patterns. It is necessary to have patterns where glass installation is concerned. After a pattern is made, it should be plainly marked according to make and model and kept for further use.

e. *Glass Cutting.* Glass cutting is divided into three operations. They are: making the cut, cracking the cut, and cutting or melting the plastic. The first two are the most difficult, since they consist of setting up stresses in the glass to guide the crack and applying forces that cause it to break along the line of these stresses. Any other stresses may cause the crack to travel away from the desired line. Stresses can be set up by supporting the glass on an uneven surface or by applying pressure to an edge or corner which is unsupported.

(1) A cutting bench made of wood or steel can be used as a support. Plywood is an ideal top for a cutting bench. The bench must be covered with a cloth cover which is soft enough to prevent scratching, yet hard enough to support the glass rigidly. The top of the bench should be larger than the largest piece of glass to be cut. For a shop that does much cutting, a revolving pattern table is ideal. With a revolving top, the workman can stand in one position while cutting a door glass. As he comes to a curve in the pattern, he rotates the table, eliminating the need for moving around and varying the cut. Smoother cuts can be made and it is easier to get the top cut directly above the inner cut. The cutting bench should be located where the temperature is the most constant. Sudden temperature changes will almost certainly result in breakage of the glass; therefore, the bench must not be located where drafts will occur.

(2) Glass should be stored vertically in bins. Each size should be stored in a separate bin and labeled. A sheet of paper placed between each sheet of glass will prevent scratching of the surface.

(3) A hardwood ruler, wider and thicker than an ordinary yardstick and usually 60 inches long, is used as a straightedge and measuring device. A small flange at one end may be hooked over an edge to eliminate the necessity of holding that end. This ruler is marked in eighths of an inch.

(4) The common glass cutter has a sharp, hardened steel wheel mounted on a pin in a steel or wood handle. Handles vary in size and length according to requirements. They can be procured in the single or multiple wheel-type. Diamond-tip cutters are also used by large organizations where

METAL BODY REPAIR - OD1653 - LESSON 2/TASK 1

all types of glass are handled. The wheel-type is best suited for cutting laminated safety glass. To keep the cutter in good condition when not in use, immerse it in a mixture of kerosene and oil. This mixture keeps the cutter clean and allows the wheel to turn freely on its shaft at all times. When cutting glass, first make sure it is thoroughly cleaned. The glass surface should first be wiped around the cutting line with kerosene. This serves as a solvent and cleans the cutting area of grease, oil stains, and other contaminants. The kerosene will also help eliminate much of the flaking from the cut.

(5) Hold the cutter between the index and second fingers. This holds the cutter firmly, and there is no tendency for it to rock back and forth as pressure is applied. Let the last three fingers of the cutting hand rest on the glass which is being cut or on the surface of the cutting table. This will steady the hand and increase accuracy. It is also less tiring.

(6) Make certain that the glass has been warmed before cutting. Glass is much easier to cut and less likely to break when warm. If glass is taken from a cold room, place it near a warm stove or warm radiator for 5 to 10 minutes before it is cut. When cutting, do not press hard on the glass. For best results, exert just enough pressure to make a fine line cut. Too much pressure causes flaking and may destroy the cut. Chips are often minor runs, but may become cracks in the glass later on. The glass should be cut the exact size of the pattern and finished $1/32$ of an inch smaller. This enables the glass to have ample room between the glass runs. Push or pull the cutter. In following a straight edge or a pattern thick enough to serve as a guide for the cutter, it is better to pull the cutter. However, when you must guide the cutter by watching a pattern placed under the glass, you will find it easier to push the cutter. This enables you to follow the pattern without having the cutter itself hiding it. In cutting combination safety glass, it is best to cut the heavy glass first, making certain that you run it clear through its thickness. Then cut and run the thinner glass.

(7) After making the cut, it must be cracked immediately or the cut will heal, making the cracking operation difficult if not impossible.

METAL BODY REPAIR - OD1653 - LESSON 2/TASK 1

(8) Laminated safety glass must be cut and cracked on each side. When making the cut on the opposite side, the pattern may be removed. The cut is then made on the other side directly over the first cut.

(9) The following steps should be taken when cutting curved windshields:

(a) The outboard light (outer layer) should always be cut first. To cut the inboard light (inner layer), turn the curved windshield over with the outboard light facing the table. Before cutting, support both sides of the curved windshield to prevent sagging.

(b) A windshield body opening improperly aligned after an accident requires special care in trimming glass for replacement.

(c) After making the score, or cut, use glass pliers with several thicknesses of cloth between the jaws. This will distribute the pressure to the radius of the glass. With a little practice, it will be found that a curved windshield is as easy to cut as flat safety glass.

f. *Plastic Cutting.* When cutting the plastic between the sheets of glass, the following procedures should be observed:

(1) After the cut has been made and cracked, it will become necessary to heat the plastic so that it can be cut or separated from the two pieces of glass. This can be done by one of the following methods:

(2) A tank or vat of hot (not boiling) water into which the piece of glass can be immersed and left for a short time (2 minutes) will cause the plastic to melt (do not place cold glass in hot water). Allow the glass to reach room temperature (70 degrees F) before dipping.

(3) Any liquid which will dissolve plastic may be used to dissolve the plastic between safety glass sheets. Methanol (alcohol) has been found to be best. After both sides of the glass have been cut and cracked, methanol is poured or squirted

METAL BODY REPAIR - OD1653 - LESSON 2/TASK 1

into the crack and left to set for approximately two or three minutes. A slight pressure downward is applied, separating the two pieces of glass.

(4) In the hot wire method, a coil of wire 1/4 inch in diameter and 72 inches long (the wire is 1/16 inch in diameter) is heated electrically. It is laid along the crack and covered with notched asbestos and lead weights. One lead from the 110 volt circuit switch is permanently connected to one end of the wire. The other lead is attached by a clip to a selected point on the wire and the switch turned on, heating the wire to a bright red. The heated plastic softens and the waste glass drops from its own weight. Waste pieces less than an inch wide may have to be removed with glass pliers.

(5) Common difficulties in the hot wire method are: bubbling in the plastic, caused by too hot a wire or too long a heating time; separation of glass sheets along the edge of the cut, caused by stretching the plastic excessively; and chipping along the cut, caused by bending the waste strip up and down, rather than pulling it straight out.

g. *Glass Grinding and Finishing.* The grinding machine is equipped with a chute which is set so the silicon carbide abrasives flowing onto the roughing wheel will hit the wheel at the edge of the recess. Place a small quantity of silicon carbide grains in the chute and saturate them with water. Then let a continuous trickle of water run onto the grains to carry a sufficient amount of grains onto the face of the wheel. The corners of the glass should not be cut too close to the outline of the pattern. A more accurate fit can be made by using the grinding wheel or belt edger on curved surfaces.

h. *Grinding.* The silicon carbide abrasive grains do the cutting (grinding) and can be reused. New silicon carbide should be added at the ratio of about two pounds to each 1000 inches of glass beveled. Before reusing carbide or mixing with new carbide, it is advisable to wash the old carbide to remove all foreign matter. This foreign matter should then be strained through ordinary window screen to remove any large chips of glass.

METAL BODY REPAIR - OD1653 - LESSON 2/TASK 1

(1) To prevent the abrasive grains from the cast iron wheel being flung over the shop area, it is suggested that a rubber inner tube be tacked around the inside of the roughing box (about one-half inch above the roughing wheel). This allows free passage of glass beyond edges of the roughing box for working edges of bevels without interference.

(2) If glass is to be rough ground oily, seam or chamfer both sharp edges first; then run glass across the wheel from left to right, holding the glass perfectly vertical if a flat edge is desired. Do not seam or chamfer the edge first, but simply roll the glass back and forth as it is being drawn from left to right, from an angle of about 45 degrees away from you to straight up. Do not roll the glass all the way toward the operator as this will chip the glass edge. When rounded on one side, turn the glass around and repeat the operation. Use the full face of the wheel to prevent grinding grooves in the face. When grooves form in the wheel, the wheel should be replaced.

i. *Installing Glass.*

(1) Glass, in terms of its installation, is either stationary (the windshield, some quarter windows, and the rear window) or it is moveable (door window, tailgate window and some quarter windows). In addition to the customary care one must take when handling glass, to protect it from impact, there are several general precautions which should be observed whenever a replacement is to be made.

(a) *Check Parts.* Be certain that the replacement part is the correct part. The size and contour of the glass must be an exact fit in the opening into which it is to be installed. Thus, it pays to take the time to verify the piece before starting the job.

(b) *Use Protective Covers.* Over all adjacent body surfaces, to minimize clean-up and avoid damage to paint finishes and fabrics, use a cover. These covers may also serve as a protection against chipping the glass or otherwise damaging the edges.

(c) *Inspect Hardware.* Inspect for bends or obstructions in the pinch weld flanges, glass run channels, frames, regulators, or whatever components may be involved in holding or moving the

METAL BODY REPAIR - OD1653 - LESSON 2/TASK 1

glass. Any indication of damage should be corrected before the replacement glass is installed, including dents in the body where the hardware fits.

(2) *Windshield Removal and Installation, Truck 1/4 ton.*

(a) Remove windshield weatherstrip filler (figure 33).

FIGURE 33. EXPLODED VIEW OF 1/4 TON WINDSHIELD.

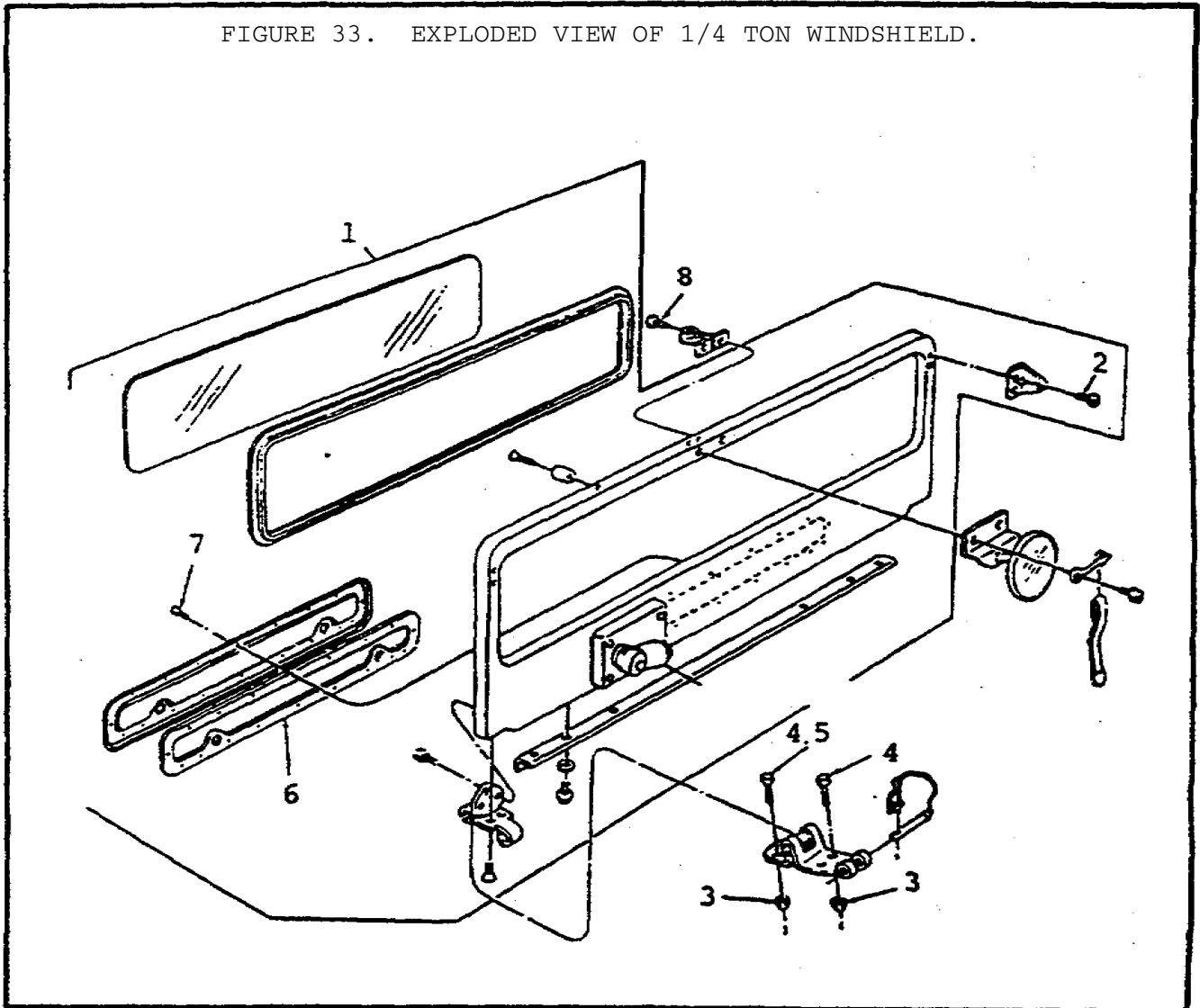

(b) After the outer weatherstrip filler has been removed, remove the glass from the weatherstrip. Care must be taken to avoid injury from sharp edges if the glass has been broken.

(c) Inspect the windshield frame assembly for dents, distortion, and broken conditions.

METAL BODY REPAIR - OD1653 - LESSON 2/TASK 1

(d) Replace the weatherstrip assembly, glass weatherstrip, and outer weatherstrip filler if they are deteriorated, hardened, or excessively damaged.

(e) To replace windshield glass, soap flange of frame with liquid soap and install glass weatherstrip over the flange of the windshield frame. Position the windshield glass in the upper left corner of the weatherstrip. Continue guiding the glass in place in the weatherstrip, using a screwdriver to slip the upper portion of weatherstrip over the glass. Position the windshield glass so the trade name reads right side up.

(f) To make the installation of the glass weatherstrip fillers easier, dip the strips into a solution of soapy water.

(g) Insert the end of the weatherstrip filler through the loop end of the tool and, using a screwdriver, insert the end of the filler into the weatherstrip at the upper right. When the end of the filler strip has been pressed in, proceed to pull the tool around the windshield until the entire strip has been inserted.

(3) *Truck, 3/4, 2 1/2, and 5 Ton.*

(a) Remove the four round head screws, four lockwashers, and four hexagon plain nuts holding inner frame upper left and right crosspieces. Remove crosspieces with attached inner corner plugs. Spread each inner frame side and bottom frame just enough to loosen safety glass and remove. Discard old tape.

(b) Inspect the windshield frame assembly for cracks or damage to inner or outer frame or damaged or loose adjusting arms. Replace any irreparable parts.

(c) To install new glass, place tape on the glass and secure with masking tape. Oil glass channels and slide the glass and tape into the channel. When finished, the oil will cause tape to swell, thereby making a watertight seal. Reinstall the top crosspiece and replace the screws.

(4) *Safety Precautions.* Glass handling Operation can be very arduous unless certain safety

METAL BODY REPAIR - OD1653 - LESSON 2/TASK 1

procedures are strictly adhered to. The following precautions are recommended:

(a) Always wear safety goggles and gloves of the approved type whenever you are handling broken glass.

(b) Discard any removed broken glass in a proper manner. A separate trash can for broken glass is recommended. Its contents should be clearly marked. Never allow scattered broken glass in the immediate work area.

(c) Advise other workers or bystanders in the area of safety precautions before attempting to remove broken glass.

(d) Never use compressed air to blow away fragments of broken glass. Small fragments of glass can become embedded in the skin. A shop (industrial type) vacuum cleaner should be used to remove fragments of broken glass. If a vacuum cleaner is not available, an oil soaked rag aids in picking up small fragments of broken glass.

(e) Removed glass, which is to be reinstalled, should be stored in a safe place. A special storage area, away from the work area, will prevent accidental breakage.

(f) Never use excessive heat near any part of the auto body where there is glass.

(g) Grinding or drilling glass is a specialized occupation. It should never be attempted by persons who are not familiar with the proper procedure.

3. Conclusion

This task introduced the specific operations required to repair glass, including safety precautions to follow when working with glass. The next task will focus on procedures to be followed in order to repair radiators.

METAL BODY REPAIR - OD1653 - LESSON 2/TASK 2

LESSON 2

OPERATIONS REQUIRED FOR
GLASS, RADIATOR, AND FUEL TANK REPAIR

TASK 2. Describe the operations required for proper radiator repair.

CONDITIONS

Within a self-study environment and given the subcourse text, without assistance.

STANDARDS

Within one hour

REFERENCES

No supplementary references are needed for this task.

1. Introduction

The radiator of a motor vehicle is an essential element of the cooling system. It must function correctly if the engine is to escape serious damage from overheating. An engine is cooled by circulating water which passes through the cylinder block. It draws out the heat and then releases it to the air while flowing through the radiator. Therefore, if this circulation is hindered or the water leaks from the radiator, immediate repairs must be made to protect the engine. Most radiator failures are caused by vibration, freezing, disintegration, strain, or collision. In tubular cores, worn or frozen tubes, broken solder between tubes and header plates, and cracked header plates are the most frequent causes of trouble. Honeycomb cores usually leak in the seams at either the soldered offsets or the header strips. Tank leaks are few, but they may appear at unsoldered joints, cracked or worn spots, or fittings.

a. Radiator Construction.

Automobile, truck, and tractor radiators consist of two water tanks (upper and lower) joined by a core which does the actual cooling. Water from the cylinder block usually enters the upper tank through the inlet, flows through the core, and leaves by the lower tank. An overflow pipe in the upper tank carries away excess steam or water. In the radiator assembly, cast metal tanks are bolted to the side members. Gaskets between the tanks and core make a watertight connection. This type of rigid radiator construction is usually used on heavy-duty trucks and tractors. Figure 34 illustrates stamped metal radiators that are formed by soldering drawn or stamped metal tanks to the radiator core. The side members are straps of steel soldered to upper and lower tanks.

FIGURE 34. STAMPED METAL RADIATOR.

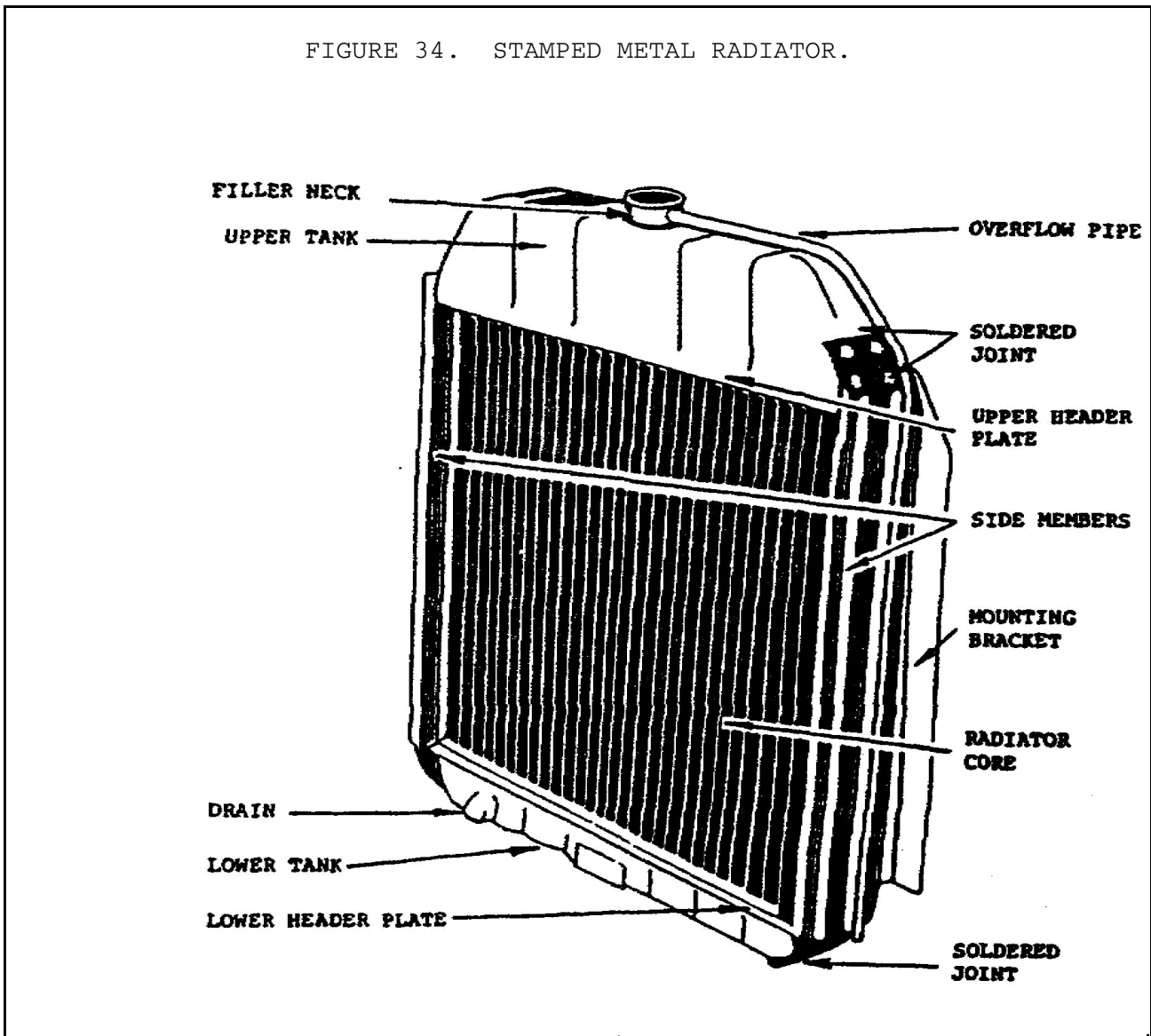

METAL BODY REPAIR - OD1653 - LESSON 2/TASK 2

This lighter construction has generally replaced the cast metal type in passenger cars and light-duty trucks, where it is usually concealed by the hood and radiator grill.

(1) *Water Tanks.* Almost all radiator tanks are cast or stamped in one piece to reduce the number of potential leaks. A baffle plate in the upper tank, below the neck, eliminates excessive splashing and distributes the water uniformly over the tank.

(2) *Radiator Fittings.* The radiator fittings are the filler neck and inlet connection of the upper tank and the outlet connection and drain valve of the lower tank. These are made of malleable iron or pressed metal. When they are manufactured as separate parts, they are brazed, soldered, bolted, or riveted to the tanks.

(3) *Tubular Core.* This type is made of many vertical tubes (drawn or seam welded) soldered through thin sheets of metal at the top and bottom (called header plates). The header plates form mounting pads for the upper and lower tanks and block passage of water from the tanks to the core except through the tubes. The tubes are generally spaced about $\frac{3}{4}$ inches apart, in two to four straight or staggered rows approximately $\frac{1}{2}$ inch apart (figure 35 on the following page). In a staggered row, twice as many tube rows are exposed to the air entering the radiator, which increases the cooling capacity. Round tubes are easily broken by the expansion of freezing water, whereas oval tubes will be distorted to some extent before breaking. The radiating surfaces of these tubes are occasionally increased by spiral fins on each tube or, much more commonly, by thin sheets of metal (horizontal fins) extending all the way across the radiator, $\frac{1}{8}$ inch to $\frac{3}{16}$ inch apart, in contact with each tube. The front edges of the horizontal fins are usually crimped or bent back to a double thickness which strengthens the radiator core. In most radiator cores, the fins are soldered to the tubes to speed the heat transfer. A tubular core radiator is generally larger than a honeycomb core radiator with the same cooling capacity.

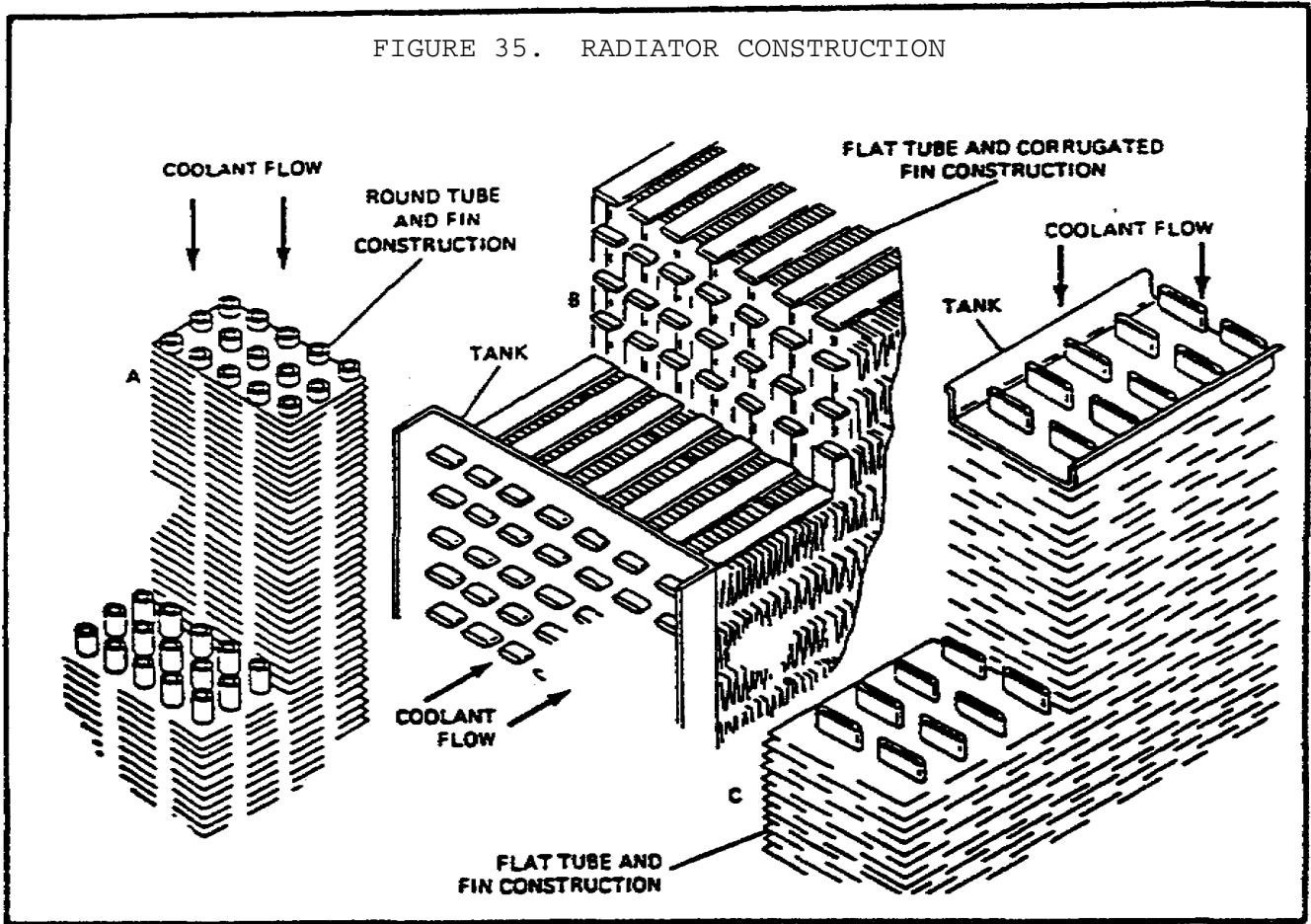

(4) *Honeycomb Core.* One form of the honeycomb core has slot-like water passages extending vertically through the core between sections of honey-like air coils. Each section has an offset stamped metal ribbon around the outside and bent fins within. Adjacent sections are soldered at the offsets, which are about 1/4 inch wide and extend about 1/4 inch in from each face of the core. The ribbon at the top of a section is called the header strip. These ribbons are overlapped, forming a seam, to construct a single tube or section. Note that this seam, extending from the center of the header strip downward to span the side walls of three entire cells, provides a broad contact area to seal the ribbons. So many different shaped air cells have been used in honeycomb construction that it is impracticable to discuss them all. After learning to recognize a few representative types, the repairman should be able to analyze the construction of any other core. In a U-shaped air-cell core, air cells are formed by U-shaped fins which zigzag from the tip of the core to the bottom, deflecting the air. The water drops almost directly from the upper tank to the lower tank in

this core. The diamond-shaped cell construction resembles the U-shaped cell construction except that the ribbons zigzag in the same pattern as the fins, thus creating diamond shaped air passages. The water passages between the ribbons are irregular and therefore more efficient in cooling, but are more easily clogged. Each fin has many bumps and ridges, called deflectors, which increase the cooling area exposed to the air. Some honeycomb cores have square cells. The water has much farther to travel here than in a diamond cell core, since the continuous water passages are alternately vertical and horizontal rather than diagonal. The honeycomb type core has several disadvantages. Although it exposes a large surface to the air, it is rather frail, and its irregular passages clog easily. Much of the external surface of honeycomb radiators dispels heat indirectly and hence loses effectiveness. It is also difficult to manufacture metal ribbon of the thinness used in honeycomb radiators without producing holes, excessively thin pieces, or steel burrs that may rust out and cause leaks. The honeycomb core is used mainly on passenger cars and light duty trucks.

b. *Radiator Cleaning.*

Radiator cleaning has three purposes: to restore perfect radiation, to facilitate soldering, and to remove obstructions to water circulation. Various chemical salts and dirt found in the water of different localities, together with grease and oil that find their way into the cooling system, collect inside the water passages of the radiator and insulate the water from the metal or stop circulation. This overheats the engine. Rust, disintegrated rubber hose, and accumulated deposits from antifreeze or stop-leak preparations will have the same effect. The water passages may be cleaned by pressure flushing, boiling, or rod cleaning. Dust, lint, and bugs often adhere to the fin surfaces in sufficient quantity to restrict the air flow through the radiator and decrease its efficiency. Spray cleaning is then necessary.

(1) *Flow Testing.*

(a) Before a radiator is cleaned, it should be flow tested to determine how badly it is clogged. The flow tester is used for this purpose. This tester indicates the exact amount of water that

METAL BODY REPAIR - OD1653 - LESSON 2/TASK 2

will flow, by gravity, through a radiator per minute. The reading indicated on the tester is then compared with the flow rate of a new radiator or with the specifications furnished by the manufacturer. The difference between the actual rate and the specified rate indicates the amount the radiator is clogged.

(b) To use a flow tester, the radiator is set on the stand provided, then a hose is connected to the radiator inlet. After the hose is connected securely, the pump is turned on, and the water flow is adjusted until a constant level is maintained in the tank.

CAUTION

Be careful when adjusting the flow rate. If you accidentally push the lever too far, the water will shoot out the top of the radiator onto the repairman. The capacity of this tester is 90 gallons of water per minute, and has given more than one person an unwanted shower.

(2) *Pressure Flushing.* Pressure flushing forces water by air pressure (approximately five psi) through the water passages of the core. It may be accomplished in two ways: direct flushing, in which water is forced through from top to bottom, as it flows in normal service; and reverse flushing. The same equipment is required for both methods: water pressure, air pressure, and a flushing gun.

(a) To clean a radiator by direct pressure flushing, screw the radiator cap on the filler neck and attach a lead away hose to the outlet connection of the lower tank. With the flushing gun in the inlet connection of the upper tank, fill the radiator with water. Because water alone is often insufficient to break loose the grease, sludge, rust, and scale within the radiator, it may be necessary to add some good radiator cleaner. When the deposits are loosened, turn the water off and admit compressed air to the radiator in short blasts, adding water between blasts until the water drains out clear and at a normal rate. The air must be applied gradually, since the radiator will stand only a limited amount of pressure.

METAL BODY REPAIR - OD1653 - LESSON 2/TASK 2

(b) Reverse flushing is similar, except that the lead away hose is attached to the inlet connection and the flushing gun to the outlet. Both methods of pressure flushing are effective when the radiator is not too badly clogged.

(3) *Boiling Out Radiators.* Sediment so firmly packed in the radiator that pressure flushing will not remove it must be boiled out with a suitable chemical solution. The vat is made so that the radiator may be lowered beneath the surface on a level controlled rack. After the radiator has boiled for a sufficient amount of time, it is removed from the vat and placed in a spray booth. In the spray booth the outside of the radiator is washed with air pressure and water to force out dirt, bugs, lint, and other material lodged between the fins, so that free circulation of air around all parts of each tube and fin is restored. Also, the interior of the radiator is back flushed with air pressure and water.

(4) *Cleaning Solution.* To make a good cleaning solution, dissolve one pound of ordinary baking soda in one gallon of water. If a commercially prepared chemical cleaner for radiators is used, follow the direction on the container.

(5) *Rod Cleaning.* If flushing or boiling is inadequate, scrape the inside of the water passages with a bristle brush or cleaning rod. For tubular radiators, this may be merely a round wire with its end rounded to avoid puncturing the tube. For honey comb or cellular radiators, use a flat strip of metal with edges and ends rounded, not quite as wide as the water passage, pushing it back and forth through the water passages.

c. *Testing Radiator for Leaks.* Before testing a radiator to locate leakage, inspect it carefully for visible leaks and solder them promptly, so that the test will be sensitive enough to reveal less obvious defects. There are two standard methods of testing: one by introducing air (under light pressure) into the radiator, immersing it in water, and locating the leaks by the appearance of bubbles; and the other, by filling the radiator with water and locating the leaks by the moisture seeping through. Either test is satisfactory, although the air test method is preferred. Mark the leaks as soon as found to facilitate locating them during repairs.

METAL BODY REPAIR - OD1653 - LESSON 2/TASK 2

(1) *Visual Inspection.* Deposits of lime or magnesia left on the outside surfaces by evaporating water indicate leaks in a radiator. Before removing a bad radiator from a vehicle, inspect it for these deposits to determine the amount of repair needed. Experience will teach how to determine the true condition of a radiator from observation. There are at least as many leaks as can be seen. Do not make an air or water test until all the leaks indicated by visual inspection have been repaired, because the effectiveness of these tests in discovering hidden leaks is lost when they reveal obvious leaks.

(2) *Air rest.* The air test, so called because leaks are indicated by escaping air, is the most efficient means of locating hidden leaks. Connect an air pressure tube directly or by a nipple to the bottom of the overflow pipe. Screw the cap tightly on the filler neck and plug the inlet and outlet with expanding or cup-shaped rubber stoppers. Immerse the radiator in a testing tank, release the air, and trace the bubbles to their source.

(a) The most practical pressure for testing is three pounds per square inch (psi) above normal operating pressure. Greater pressures will damage the delicate construction of radiator cores. Frequently, leaks will appear at low pressure but not at high pressure, which closes the joints with accumulated lime and magnesia deposits or with expanded metal.

(b) The air pressure system used by garages for tire inflation, consisting of a compressor, motor, pressure tank, gages, and reducing valves, is very satisfactory for radiator testing when the work is enough to keep several men busy. When no compressor is available, an ordinary tire pump will supply enough air pressure.

(3) *Testing Bench.* Since testing is a dirty job, arrange the shop equipment systematically to minimize disorder. The testing bench should be placed near an air pressure source and water lines, preferably endwise to a wall under or just back of a window, to light the radiator adequately. Prevent damaging the radiator by excessive air pressure by using an air pressure gage, and be guided by it.

METAL BODY REPAIR - OD1653 - LESSON 2/TASK 2

(4) *Field Test Task.* A field test tank consists of a one piece canvas bag with wooden staves in pockets to hold the sides up, and four round poles running through canvas loops to support the rim. A rubber mat protects the bottom of the tank from being torn by the radiator. When the tank is collapsed, two poles are removed and placed inside the tank, which is then rolled inside the mat and fastened with five flat metal hooks.

(5) *Locating Leaks.* Locating the leaks when bubbles rise is often difficult. Raise the radiator in the tank until the source of the bubbles is at the surface of the water. Locate as many large leaks as possible, drawing upon the knowledge of radiator construction; quite frequently the large ones can be detected more easily at a lower pressure. Repair these and retest for smaller ones. If water leaks in and remains for a later test, it may seal the compressed air and prevent it from escaping, and thus cause leaks in the bottom to remain undiscovered. Then on the last test, turn the radiator over in the tank.

(a) Two leaks occurring exactly opposite one another, one near the front of the core and the other at the back, should not be confusing. If testing a honeycomb core, stand it on edge, allowing the bubbles to come up the face. A tubular core should be raised until only the lower rows of tubes are immersed in the water. An accurate idea of the location of leaks is based upon a thorough understanding of core construction. To locate open seams at the back of a tube, use a sharp pointed tool.

(b) To find very small leaks, place the bench light in back of the radiator so that the interior of the core can be seen. Stand the radiator on the bench and spread the supposed leak with flux or soapy water from an eyedropper, oilcan, acid brush, or swab. Compressed air seeping through the leak will cause the liquid to foam.

(c) As heavy truck cores occasionally come to the shop with water tanks removed, the water passages or tubes may have to be closed before tests can be started. For a honeycomb core, solder dummy tanks to the header strips. These may be made of discarded tanks or plate metal, to one of

METAL BODY REPAIR - OD1653 - LESSON 2/TASK 2

which a tube has been soldered for the air hose. The tool shown in figure 36 for testing individual tubes, is simply a core shaped rubber stopper with a 1/4 inch diameter hole at the large end, increasing abruptly to 1/2 inch at the small end. A brass tube extends through the 1/4 inch opening to the beginning of the 1/2 inch hole. A washer soldered onto the brass tube prevents it from being pushed in further. The air hose is slipped over the tube. To use the test tool, submerge the core in a test tank, place the tool over one end of the tube to be tested, and allow the water in the tube to be blown out by the air pressure. Then, with the radiator level, close the opposite end of the tube with a finger. Bubbles will then appear wherever the tube leaks.

FIGURE 36. TEST TOOL FOR TUBULAR CORES.

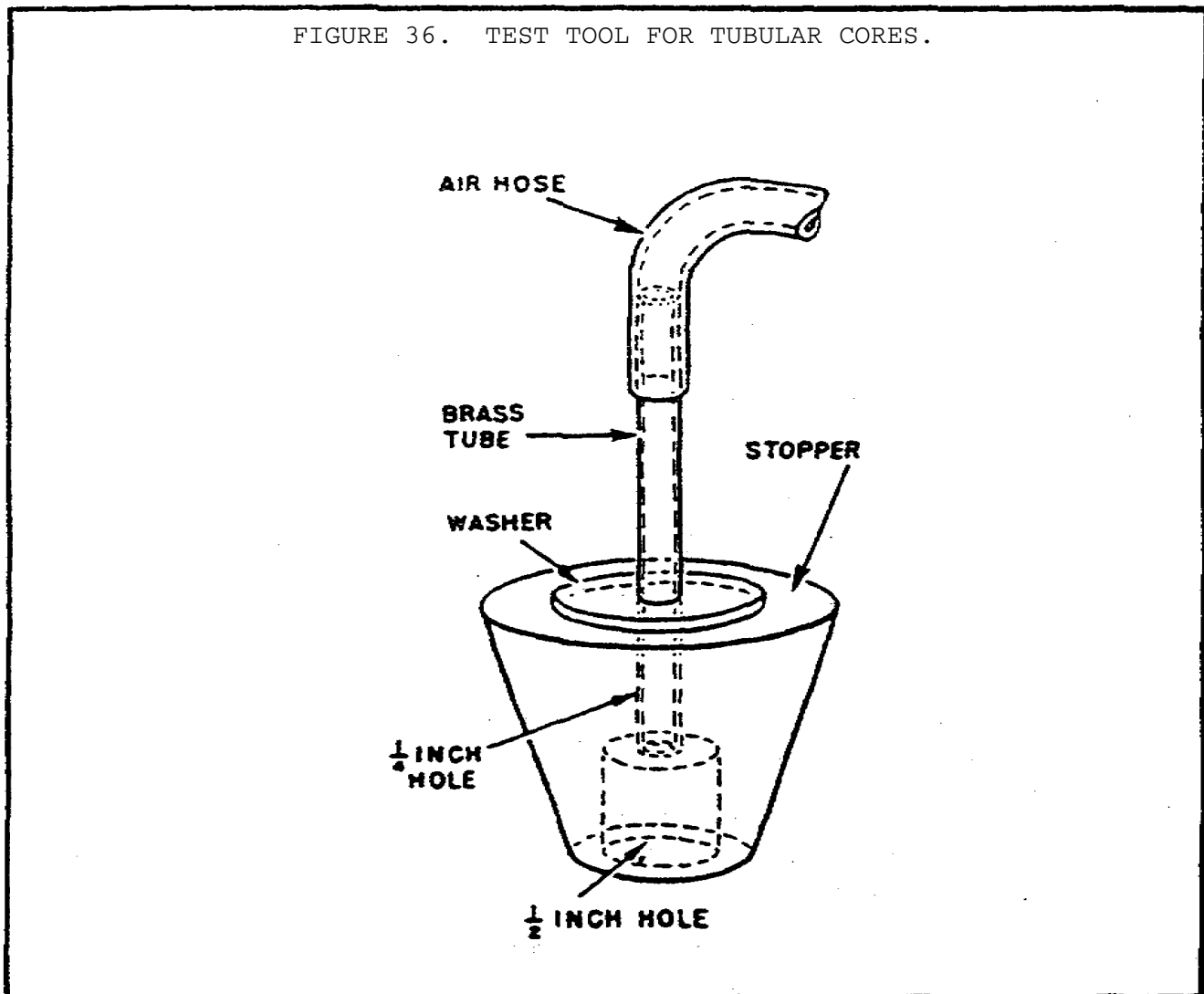

(6) *Water Test.* The water test, so called because leaks are indicated by escaping water, replaces the air test when equipment is limited, or

METAL BODY REPAIR - OD1653 - LESSON 2/TASK 2

supplements it when the air test is suspected of being inadequate. Sediment and lime deposited about leaky joints may be forced into the joints by air pressure when the radiator is air tested, sealing the leak. A leak at the joint of tubes and header plates often refuses to show up under air pressure. For this reason, dry the radiator after repairing the leaks found by air pressure, and test by the water method. With the radiator thoroughly dry, remove the plug from the filler neck and fill the radiator with water, being careful not to run it over or spill on the outside. Examine the core carefully for leaks. Place the air hose over the lower end of the overflow tube and hold the palm of the hand over the filler neck, while five pounds of pressure is applied against the water.

(7) *Marking Leaks.* Adopt a uniform system of marking leaks. For tank leaks, a sharp pointed tool is most adaptable. For honeycomb cores, bend a strip of tin or small wire in the shape of a clothespin and insert it, bent end first, at the leak. Let one end of the "clothespin" project farther than the other to indicate which side of the cell is leaking.

d. *Radiator Disassembly.* When work is being performed on vehicle radiators using the oxyacetylene welding torch as a source of heat, the flame is always adjusted to a carburizing flame.

(1) *Side Member Removal.* Light and adjust torch to a carburizing flame. Apply heat to the top radiator tank where the side members are joined by solder (one side at a time). When the solder melts, move the top of the side member away from the upper tank until the metal cools, then heat the bottom part of the side member and remove it from the radiator.

(2) *Overflow Pipe.* Melt any solder tacks which might be holding the overflow pipe to the upper tank. Beat the overflow pipe at the place where it enters the filler neck and remove it from the radiator.

(3) *Upper Tank Removal.*

(a) *Tapping.* Using the oxyacetylene welding torch, direct the flame to a point where the upper tank and header plate join. When the solder starts to melt, tapping is commenced, moving all the way

METAL BODY REPAIR - OD1653 - LESSON 2/TASK 2

around the tank until the cycle is completed. The handle of a wire brush is ideal for this operation. As the torch is moved the brush handle follows, keeping approximately three inches to the rear of the flame at all times. The vibration, set up by the constant tapping, prevents the solder from resealing.

(b) *Air Blowgun.* To protect the eyes against molten solder and fluxes, goggles or face shields must be worn when using this method. Precautions must be taken that persons walking or working nearby are not exposed to the fluxes or hot solder that might be flying through the air. Apply the torch until the solder starts to flow; quickly blow out the molten solder with a full blast of air. Proceed around the entire tank in this manner, heating two or three inches of seam at a time.

(4) *Lower Tank.* The lower tank is removed in the same way as the top tank.

(5) *Filler Neck.* Using a pair of slip joint pliers, hold the filler neck and apply heat to the solder until melted, and remove from the upper tank. It must be determined what type metal has been used for the filler neck, inlet pipe, and outlet pipe. Some large stationary-type engines, such as light plants, have radiators that may have cast iron parts. Great care must be taken not to destroy the tinned surface of these metals. If the tinned surfaces are destroyed, they must be retinned before assembly.

(6) *Inlet Pipe.* Hold the inlet pipe with a pair of pliers, apply heat, and remove.

(7) *Baffle Plate.* The baffle plate is soldered to the inside of the upper tank. On some radiators, baffle plates are riveted and soldered. Rivets should be removed prior to applying heat. Once the rivets are removed, heat is applied to the baffle plate and it is removed in the same manner as one not riveted.

(8) *Outlet Pipe.* The outlet pipe is removed in the same way as the inlet pipe.

METAL BODY REPAIR - OD1653 - LESSON 2/TASK 2

(9) *Drain Cocks.* Drain cocks are found at the bottom of radiators and are attached to the lower tank in one of the two following places:

(a) If the drain cock is attached to the outlet pipe, it may be removed by unscrewing it.

(b) If the drain cock is not attached to the outlet pipe, it (or a tapped fitting) is sweated to the bottom tank and is removed upon the application of heat.

e. *Radiator Assembly.* A good soldering job is dependent upon the complete tinning of the metal prior to soldering. The use of a proper flux, the close union of the parts to be soldered, and the application of adequate heat to make the solder flow freely are important.

Tinning compound is composed of powdered tin and other chemical ingredients compounded together. When mixed with water, it makes an oily liquid. This liquid, when applied to a metal surface and heated, will leave a deposit of tin or tin coating. It is not intended for use with aluminum or magnesium. The compound is mixed with a half can of water in its own container. The flux aids the compound in cleaning the metal. It is a white powder and is mixed on a ratio of 1 pound of flux to five pints of water. This flux is ideal for use on radiator work after the proper tinning of the metal has been accomplished. It will cause the molten solder to have an excellent capillary action. When using flux, caution must be taken to keep it out of any open scratches or cuts in the skin. Rubber gloves should be worn when working with this flux.

The most commonly used flux is hydrochloric (muriatic) acid which has been cut (killed) by adding pure zinc. In preparing hydrochloric acid for use in soldering, place the desired quantity in a crock or other earthen vessel and add zinc until it is saturated. Uncut muriatic acid is a yellowish color. It becomes clear after it has been cut with zinc. Muriatic acid is objectionable because of its effects on the workman, due to the gases given off when heated. The reaction of hydrochloric (muriatic) acid when zinc is added produces an explosive hydrogen gas; therefore, the solution should be prepared outdoors.

METAL BODY REPAIR - OD1653 - LESSON 2/TASK 2

The most common material used as a soft solder bond is an alloy composed of 50 percent tin and 50 percent lead. There are two types of solder manufactured for the repair of vehicle radiators. These types are acid core and wire solder.

All solder is removed from the parts prior to assembly. Any area that shows signs of not being tinned must be retinned. If the oxyacetylene torch is used, the flame is adjusted to a carburizing flame. If the soldering iron is used, the copper point must be properly heated and tinned. If the copper point is too cold, the solder will not flow freely and will not stick to the metal. If the copper point is too hot, the solder will form little globules that will run off the surface of the metal. A small amount of solder properly flowing into the joint will give a much better result than a joint that has solder piled up in a rough seam. A good soldering job is recognized by the manner in which it flows into the joint. A rough, lumpy seam indicates a poor job. A seam or joint of this kind should be gone over with a properly heated iron to flow down the ridge and to pick up the excess solder. The speed with which soldering can be done with a torch flame is an advantage. It is preferred over the soldering iron for most purposes. The method of applying solder with the torch is similar to the method used with the soldering iron. With the torch, solder is melted and flows directly upon the surface of the metal. The heat of the metal and the torch flame are both essential to liquefy the solder. Satisfactory requirements of a torch flame are:

- (1) Will not be extinguished by the fumes of the flux or acid.
- (2) Gives sufficient heat to accomplish quick fusion of the solder, and yet not hot enough to damage the metal being soldered.
- (3) Adjusted to suit the job to include a long, slim, needle-like flame capable of reaching difficult places, as well as a heavy, bushy type flame for dismantling parts.

Various gases can be used for soldering with satisfactory results. Hydrogen gas, supported by compressed air, produces a flame that is very satisfactory. This gas may not always be available. Acetylene gas is also used, but is not

METAL BODY REPAIR - OD1653 - LESSON 2/TASK 2

the most satisfactory. Because of the high degree of heat generated by using acetylene and oxygen, there is a danger of damaging light metal. City or natural gas is the best; next is liquid petroleum; and last oxyacetylene.

After the metal has been cleaned and retinned, reassembly of the radiator can begin. There is no prescribed pattern of reassembly except the radiator baffle plate must be installed first. All parts are fluxed with suitable flux and soldered together. The upper tank is set in place on the core and tack soldered on each corner. After tacking in place, solder each end. After the ends are soldered, start on one corner of the tank and solder the tank all the way around.

f. *Repairing Radiator Leaks.* After leaks have been marked, the radiator is removed from the test tank and repaired.

(1) *Seam Leaks.*

(a) Apply heat and remove the old solder, using the air gun or wire brush method.

(b) Old solder is removed for a distance of three inches on each side of the leak.

(c) Using a squirt bulb or an acid brush, flush the seam with muriatic acid.

(d) Beat the seam until the acid boils, then quickly blow or wire brush out the acid. This removes all dirt and oxides, which are the cause of poor solder bonding. Care must be taken not to direct the airstream or wire brush toward anyone when removing acid or hot solder.

(e) Flush seam liberally with flux, using a squirt bulb or acid brush. Keep seam warm with torch while flushing. Remove all flux with moderate airstream.

(f) Proceed with soldering in the usual manner.

(2) *Patching Cracked Tanks - Brass Radiator Tanks.* Almost all radiator tanks are cast or stamped in one piece to reduce the number of potential leaks.

METAL BODY REPAIR - OD1653 - LESSON 2/TASK 2

(a) Cracks in stamped brass radiator tanks must be patched. Spreading solder over the crack will not make a permanent watertight repair.

(b) Wire brush or scrape the area around the crack one inch larger than the patch to be installed. Dig down into the crack itself with a pointed tool. Tin the cleaned areas and the underside of the patch, wiping them clean while the solder is in a molten state.

(c) Fit the patch in place as perfectly as possible, following the contours of the tank. All patches should have rounded corners.

(d) Hold the patch in place with a screwdriver and apply heat. The proper amount of heat will be indicated when a stick of solder will melt when touched to the patch.

(e) If proper care has been taken during the tinning operation, the patch will be strong and watertight. Hold the patch in place until the solder has set.

(3) *Blocking of Tubes - Cellular (honeycomb) Radiators.* A damaged tube may not need to be repaired; it can be blocked off. Fifteen percent of the tubes in a radiator may be blocked off without adverse effects.

(a) Heat face of tube near header plate and spread open with an improvised tool made from an old hacksaw blade sharpened on one end to the shape of a chisel.

(b) Thoroughly tin the inside of the tube with tinning compound, using an acid brush to apply the tinning compound.

(c) Apply flux and fill tube with solder.

(4) *Tubular Core.*

(a) Heat fins at the header plate and raise fins one-half of an inch on each side of the tube to be blocked.

(b) Apply heat to the tube and blow out the solder with an airgun.

METAL BODY REPAIR - OD1653 - LESSON 2/TASK 2

(c) Reheat the tube at the header plate, and using a pair of needle nose pliers, bend the tube down and out to one side and remove from the header plate.

(d) Retin the area where the tube was removed from the header plate.

(e) Apply flux and solder the hole shut.

(f) Repeat the same operation at the other header plate.

g. *Straightening a Bent Radiator Core.* A bent radiator core can be straightened, provided the bend is gradual. If it is so sharply kinked that the water tubes or passages are collapsed, it should not be straightened. Straightening is done in a press, with boards above and below the core, to spread the pressure and protect the air fins. Hydraulic presses may be used for this operation.

WARNING

Epoxy materials may cause skin irritation. If epoxy resins and hardeners come into contact with the skin, wash the skin thoroughly with mild soap and water. Always use epoxy resins and hardeners in a well-ventilated area.

h. *Repair of Aluminum Radiators.* Damaged radiators are repaired with epoxy resins, glass cloth, and aluminum screen. Due to the limited storage life of the resin and hardener, repair of aluminum radiators with material which has been in storage for more than one year is not recommended. Mixing ratios of epoxy resins to hardeners normally are given by weight. The ratio by weight is 100 parts epoxy to 14-17 parts hardener.

When weighing equipment is not available, 5-6 parts epoxy resin by volume to 1 part hardener by volume is the recommended volume mixing ratio. The 5 to 1 ratio will produce a compound with a shorter pot life (working time) than the 6 to 1 ratio (working life of the resin hardener mixture is approximately 15 to 25 minutes at 75 degrees F). If desired, the entire contents of both the hardener and resin cans may be used by adding the contents of the hardener

METAL BODY REPAIR - OD1653 - LESSON 2/TASK 2

can to that of the resin, which will result in the correct mixing ratio.

i. *Repair Procedures for End Tanks.* For holes or lacerations in the end tanks of the radiator, trim away ragged edges and clean with a wire wheel. Blow away dust and clean the repaired area with naphtha or paint thinner followed by alcohol.

NOTE

The presence of oil in the repair area will result in poor adhesion. Repair of holes larger than approximately 1 inch in diameter is not recommended.

(1) Cut two pieces of aluminum screening slightly larger than the hole and then wire together so that the radiator material is sandwiched between the screening.

(2) Prepare a proper amount of epoxy resin and hardener as directed in subparagraph i above. Add a sufficient amount of silica to obtain a workable consistency (soft, putty-like).

(3) Thoroughly saturate the screening with the epoxy mixture.

(4) Cut a piece of glass cloth larger than the hole, saturate with the epoxy mixture, and form it over the hole and cleaned surrounding area. For holes larger than 1/2 inch in diameter, a second cloth layer is recommended. Place a piece of release film on the second patch and with a hardwood depressor, work out the trapped air pockets by working from the center of the patch outward.

(5) Apply another cast of epoxy mixture over the glass cloth.

NOTE

Cure will be slow in temperatures below 70 degrees F. Cure may be shortened to about four hours by placing a heat lamp over the patch area and gradually increasing the heat intensity by moving the lamp closer to the repaired area.

METAL BODY REPAIR - OD1653 - LESSON 2/TASK 2

CAUTION

Repair area temperature must not exceed 100 degrees F anytime thereafter. Minimum distance between the heat lamp and repair area is two feet, regardless of the temperature requirement.

(6) Allow the completed patch to set undisturbed for 16 to 24 hours.

j. *Repair Procedures for Cores.*

(1) For lacerations in the core, remove fins approximately 1/2 to 3/4 of an inch beyond the damaged cross tubes.

(2) Remove jagged edges from the cross tubes, clean with a pencil-type wire or grinding wheel, and continue preparation.

(3) Prepare a proper amount of epoxy and hardener. Also add sufficient amount of silica to obtain a workable consistency (soft, putty-like).

(4) Force the epoxy mixture into the cross tube and close the tube with pliers. Apply a second coat of epoxy mixture over the closed-off tube and immediate surrounding area. Allow the repair to dry.

CAUTION

Do not test aluminum radiators in a tank that has been or is being used for testing copper/brass radiators. Fluxes used in copper/brass radiator repair will contaminate the water in a test tank and will attack aluminum.

(5) *Test.* To test the radiator repair, block all inlet and outlet connections, install pressurizing equipment, and apply 18 psi for a period of three minutes while the radiator is immersed in water. Absence of air bubbles denotes a satisfactory repair.

METAL BODY REPAIR - OD1653 - LESSON 2/TASK 2

(6) *Cleaning and Painting.*

CAUTION

Radiators should never be painted with ordinary lacquers, enamels or paints as these insulate the heat transfer. This reduces the cooling efficiency. Always use non-insulating radiator core paint.

After all leaks have been repaired, the radiator should be painted. A non-insulating paint should be used. Before painting, the radiator should be cleaned, dry and free of all flux residue.

NOTE

No more than one coat of paint will be applied to radiator cores on tactical wheeled vehicles which are subject to painting.

2. Conclusion

This task introduced the specific operation required to repair radiators. The next task will present the procedures to be followed for repairing fuel tanks.

METAL BODY REPAIR - OD1653 - LESSON 2/TASK 3

LESSON 2

OPERATIONS REQUIRED FOR
GLASS, RADIATOR, AND FUEL TANK REPAIR

TASK 3. Describe the operations required for proper fuel tank repair.

CONDITIONS

Within a self-study environment and given the subcourse text, without assistance.

STANDARDS

Within one hour

REFERENCES

No supplementary references are needed for this task.

1. Introduction

Fuel tanks for motor vehicles are made of terneplate ranging in thickness from No. 24 (0.0156 inch) to No 18 (0.050 inch) U.S. standard gage, and joined by welded seams. Fittings such as the filler neck, drain valve, and fuel line connections are soldered to the tank. Baffle plates inside the tank offset excessive splashing and foaming of the fuel when the vehicle is in motion. Figure 37 (on the following page) illustrates typical construction for a fuel tank. Leaks may occur in the seam welds or soldered joints because of vibration, strain, or faulty construction. Occasional leaks in the tank itself are caused by sharp objects such as stones or bolts picked up by the wheels of the vehicle from the road which can be thrown against the fuel tank.

2. Types and Construction

Fuel tanks are made in various shapes and sizes, from the smallest for outboard motors to the largest rail tank cars. The most common type of

FIGURE 37. TYPICAL FUEL TANK CONSTRUCTION.

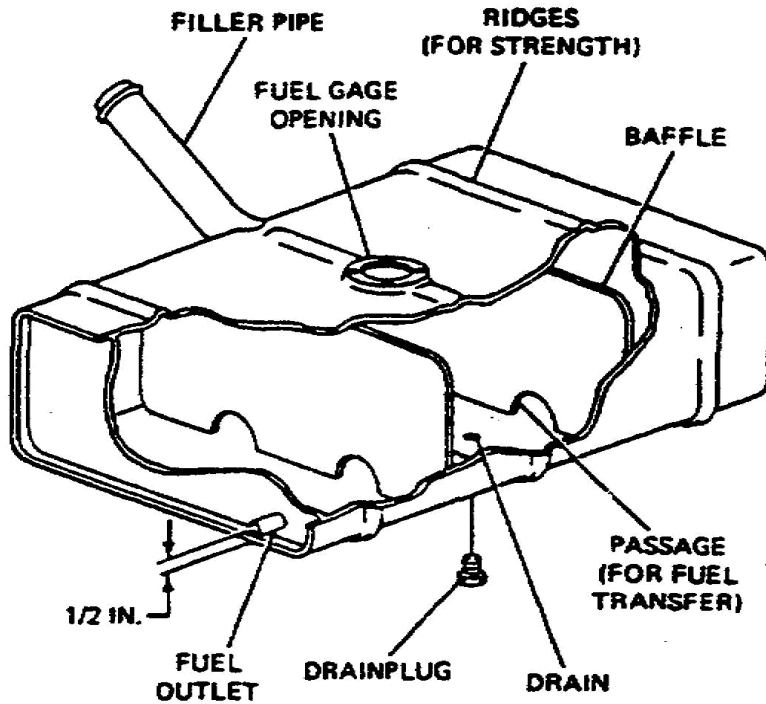

fuel tank used in the Army are wheeled vehicle tanks (terneplate), fiberglass fuel tanks, cell or bladder-type tanks, and fuel compartments, which are part of tracked vehicles. Terneplate is thin gage, low-carbon steel which is coated on both sides with lead. During its manufacture, the steel is run through an acid bath and then through a hot-lead dip. The lead coating adheres to the metal, giving it a tinned coat. This tinned coat prevents rust from forming on the inside of the tank, and also makes repairs easier.

Regardless of their shape and size, all fuel tanks must be designed to prevent static electricity and excessive splashing. Baffle plates are used for this purpose. Figure 38 (on the following page) shows the inside of a fuel tank used on a 2 1/2 ton Army vehicle. Baffle plates are secured to the top, bottom, and sides of the tank by spot welding or soft soldering. Newer type vehicles being issued to the Army have fuel tank baffle plates spot welded to prevent them from breaking loose.

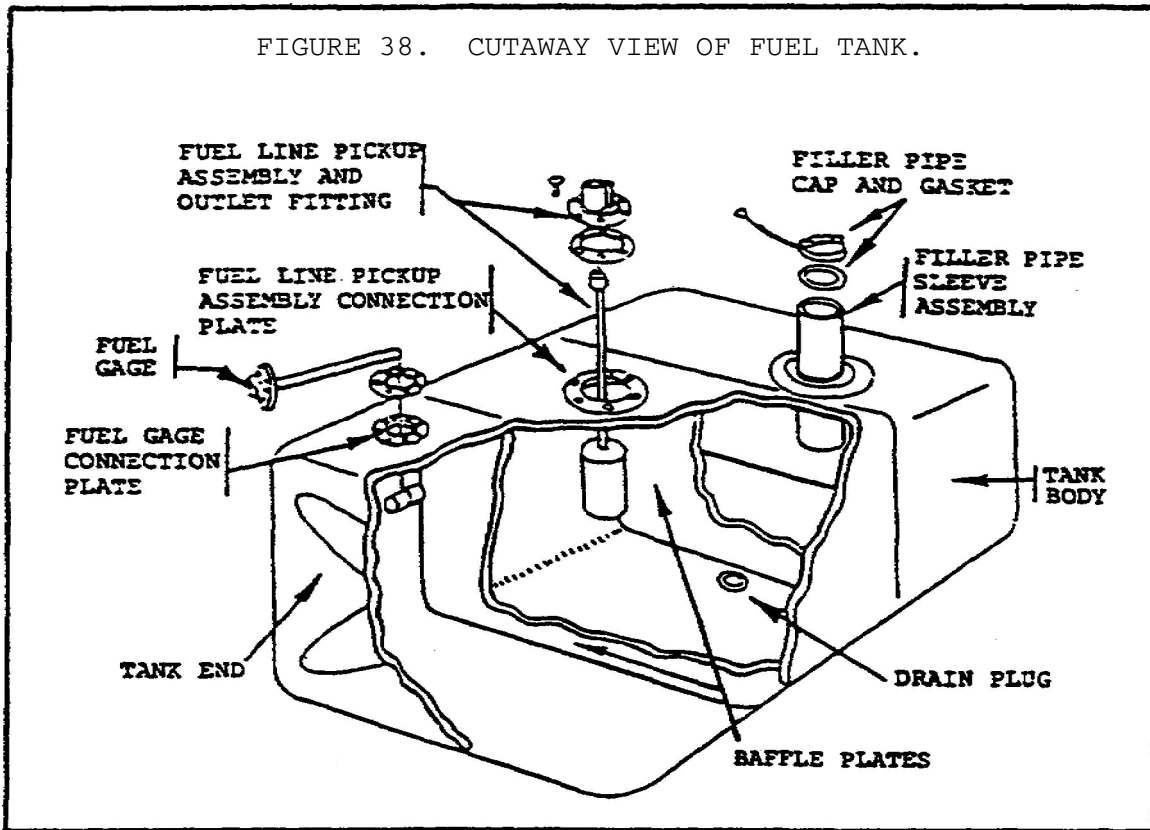

3. Repair Operations

a. *Fuel Tank Body and Ends.* The tank body and ends are secured together in one of three ways:

- (1) Crimped and soldered.
- (2) Tank ends flanged and seam welded to the tank body.
- (3) Aluminum fuel tanks brazed or fusion welded.

Commercial type vehicles have upper and lower tank halves seam welded together in the center to make a complete unit.

Fuel tanks on 3/4 ton and larger combat-type vehicles are flanged and seam welded.

Fuel tanks on 1/4 ton (Jeep) combat-type vehicles are either seam welded or soldered.

After one end has been installed on the tank body, the baffle plates are spot welded in place. The

METAL BODY REPAIR - OD1653 - LESSON 2/TASK 3

remaining tank end is secured in position by seam welding.

b. *Fuel Tank Fittings.*

(1) *Filler Neck.* Filler necks on fuel tanks are manufactured from cast iron, aluminum, or low carbon steel, then coated with lead, stamped to shape, and soldered in place.

(2) *Filler Tube (sleeve) Assembly.* The filler tube is a round cylinder manufactured from terneplate. It is used as an extension of the filler neck to prevent fuel from sloshing out of the tank while being filled. Located in the bottom of the sleeve is a screen (brass wire mesh) to prevent dirt or other foreign particles from going into the tank. When fuel is to be added to the tank, the sleeve is pulled up and locked in position.

CAUTION

When repairing a fuel tank, make certain that the sleeve lock is in proper working condition. If it does not make good contact with the tank, static electricity may result when filling and an explosion could result.

(3) *Filler Cap.* All fuel tank filler caps are not alike. Some are plain lock-on types while others are designed not only to prevent the gas from sloshing out, but to allow combat-type vehicles to be used in deep-water fording operations. Figure 39 (on the following page) illustrates a cross section view of a pressure type fuel tank filler cap. Operation of the pressure cap is describe below.

(a) As road heat comes in contact with the fuel tank, the fuel will start to expand, causing the air within the tank to be compressed. At this time, pressure put on the compression spring opens the vent and lets the expanding fuel vapors escape from the tank.

FIGURE 39. PRESSURE-TYPE FUEL TANK FILLER CAP.

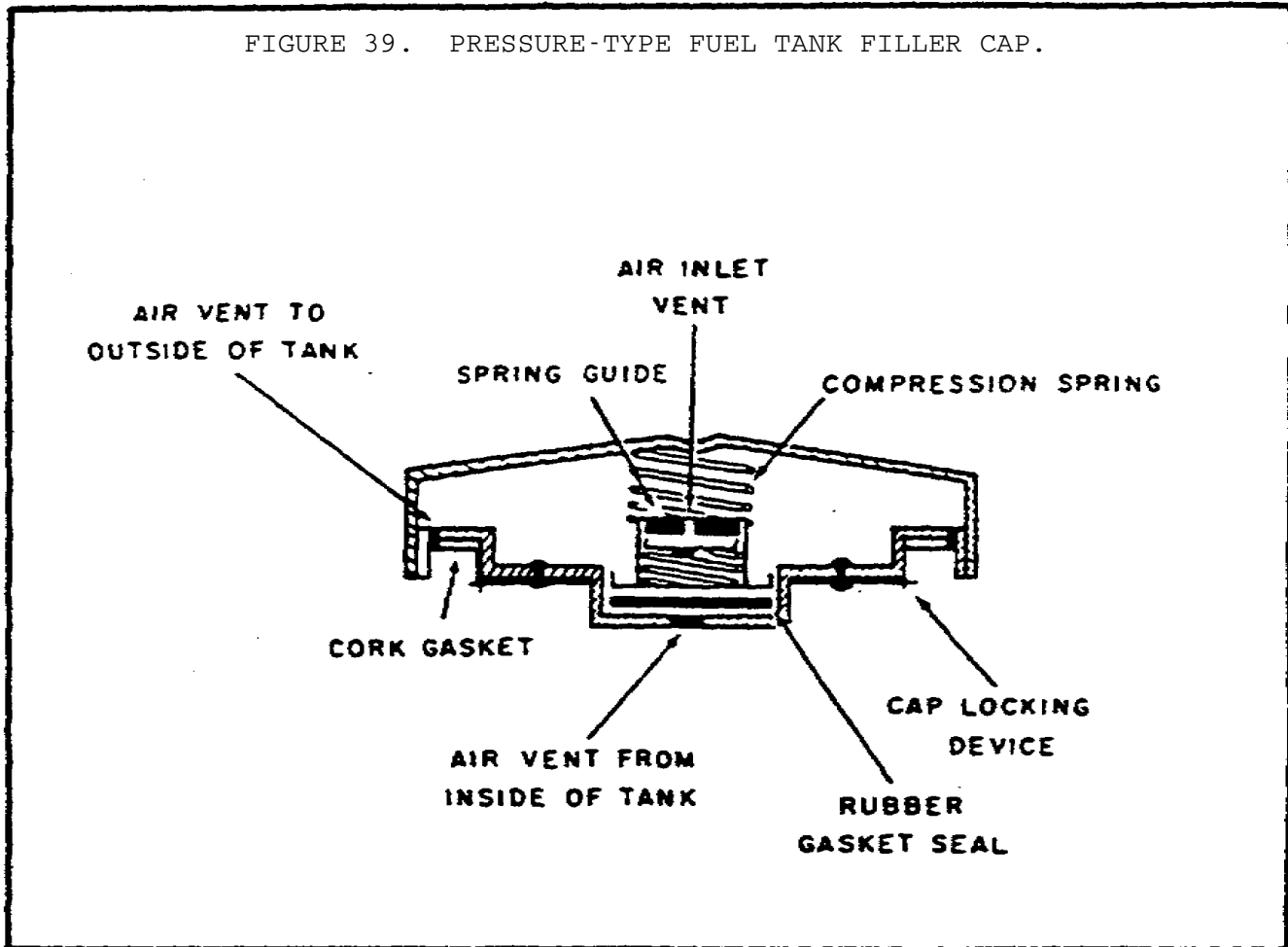

(b) The reverse of this (paragraph 3b(3)(a)) occurs when the tank and fuel cool. Air must be brought in from the outside to replace the area left by the shrinking fuel. Atmospheric pressure, which is greater than the pressure within the tank, forces the inlet vent open, allowing air to rush into the tank. When the tank pressure equals atmospheric pressure, the air vent closes.

(4) *Fuel Pickup Connection Plate.* The connection plate is manufactured from low carbon steel, coated with lead, and soldered to the tank body. The plate has holes drilled into it and tapped to receive the fuel line pickup assembly which is secured in place with screws.

(5) *Fuel Gage Connection Plate.* Construction and method of attachment is the same as the pickup plate.

(6) *Drain Plug.* The drain plug is a steel plug with pipe threads. The drain plug fitting is manufactured from low carbon steel coated with

METAL BODY REPAIR - OD1653 - LESSON 2/TASK 3

lead, with internal pipe threads, and soldered to the tank body.

c. *Fiberglass Fuel Tanks.* Fiberglass fuel tanks are constructed entirely of fiberglass, except for the fittings or connections. Because of their light weight, durability, and seamless construction, they are used frequently on armored personnel carriers and self-propelled artillery vehicles.

(1) Their construction makes it possible to install them in irregular spaces. They are used mainly in vehicles that are subject to vibration and travel over rough terrain. Because of their irregular shapes, they do not need baffle plates.

(2) Cell or bladder-type tanks are constructed of three layers of synthetic material and a protective lacquer coating. They are similar to a large balloon and are square or round in shape. They are sometimes used as temporary or portable fuel cells and most units in the field use them for fuel points. Their thick-wall construction provides an excellent shield for foul weather or abuse. When not in use, they easily fold away for storage.

(3) The fuel compartment is not an independent section or a tank and cannot be removed from the vehicle. It is constructed as an integral part of the vehicle's hull. The composition and shape of the full compartment is determined by the design of the parent vehicle.

d. *Testing for Leaks.* Three methods are used to locate fuel tank leaks:

(1) Visible leaks are found by looking for stains left on the outside of the tank. Seepage marks will be dark brown or dark red (depending on what type of gas is used) stains on the tank. Cracks may be located by careful observation of the tank.

(2) The best test is the underwater air test. The tank must be cleaned prior to testing. It is then made airtight by sealing the fluid gage opening, the fuel filler pipe opening, and the drain plug, and then attaching an air hose connected to the fuel outlet connection. Place the tank in a vat or a canvas tank. Apply compressed

METAL BODY REPAIR - OD1653 - LESSON 2/TASK 3

air of no more than five psi, and look for air bubbles. Mark these spots and repair.

(3) Another method is to fill the tank with clean water, soap the outside of the tank, replace the tank cap, and attach an air line to the fuel outlet connection. Apply five psi of air pressure and look for any bubbles which may appear on the outside of the tank which indicates a leak.

(4) Testing for leaks in the fiberglass and cell (bladder) type of fuel tank is more or less a matter of visual inspection. In cell (bladder) type fuel tanks, leaks may occur because of punctures, cuts, abrasions, blisters, and ruptures. Scuffs and coating damage may also cause occasional leaks.

e. *Cleaning.* Before repairs, fuel tanks must be cleaned thoroughly. This is absolutely necessary as a safety precaution-against fuel or vapors remaining in the tank. Never be misled by the fact that the tank is empty of liquid. There may be vapors in a tank that has been empty several weeks or months. When heat is applied to the tank, the metal expands and any fuel that may have been trapped in the seams vaporizes and explodes.

(1) The best method of cleaning a fuel tank is the live steam method. This consists of using a steam cleaner to remove any fuel or fumes that may still be present. After flushing the tank with water, remove all tank units and fittings such as the drain plug, fuel pickup assembly, gas gage, and filler cap. Place the steam cleaner hose in the filler neck and steam the inside of the tank for at least 45 minutes with live steam. Repairs should be done immediately after cleaning.

(2) The exhaust-and-air method does not require anything more than a vehicle that runs and a 1 1/2 inch flexible pipe. Remove the tank from the vehicle. Place the 1 1/2 inch flexible hose into the gas tank filler neck. Connect the other end to another vehicle exhaust pipe. Let the vehicle run for at least 25 minutes. After the exhaust fumes have been running into the fuel tank for at least 25 minutes, blow the tank out with compressed air and start repairs immediately. By starting repairs immediately, vapors have not had a chance to build up again.

METAL BODY REPAIR - OD1653 - LESSON 2/TASK 3

(3) The live steam and the exhaust-and-air methods are used mainly forterneplate tanks, but they can also be used on fuel compartments. The water-filled method is another means of cleaning fuel tanks. After locating a leak, fill the tank completely with clear water and replace the fuel cap. Then turn the tank until the leak is in the topmost position and repair with a soldering iron only. For fiberglass and cell-type tanks, a plain water flush is the best method of cleaning.

(4) *Patching.* Before patching a damaged tank, first remove it from the vehicle and remove all vapors. The area to be patched must be cleaned and tinned at least two inches beyond the crack in all directions. When cutting a patch, use galvanized metal large enough to extend beyond the crack at least 1 inch in all directions. Round all corners and tin the metal on the side that is to make contact with the tank. Place the patch on the tank and sweat solder together. The last step is to test with five psi air pressure.

(5) *Safety Rules.* Safety rules for fuel tank repair should be strictly enforced.

(a) Do not depend on your eyes or nose to decide if it is safe to put an open flame on a fuel tank; steam it first. A very small amount of residual gasoline or other explosive liquid can cause a serious explosion.

(b) Never use oxygen to ventilate a fuel tank.

(c) Never place a lighted torch or flame of any kind in the fuel tank opening to test for vapors after it has been cleaned.

(d) Always use compressed air to clean the exhaust fumes from a fuel tank when the exhaust method has been used to remove fuel vapors.

(e) Never use an oxyacetylene torch to remove tops of 55 gallon drums. Always use a hammer and cold chisel. All types of 55 gallon drums should be cleaned before removing the tops. Vapors of some liquids will explode upon the first spark. Since cold chisels are made of steel, a spark could very easily be struck. With priority on safety, only drums which contain known non-toxic substances should be used.

METAL BODY REPAIR - OD1653 - LESSON 2/TASK 3

Before the actual repair of a tank, the vapors must be removed and the filler neck cap replaced. After connecting the air hose to the fuel outlet pipe connection and placing the tank in a water vat, observe the tank for any leaks (with air pressure set at five psi). Remove the tank and shut off the air supply. To repair the damaged area, first heat the area, clean or wire brush and tin the area, and then solder the leak. The final step is to retest with air to make sure the damaged area was repaired properly.

METAL BODY REPAIR - OD1653 - LESSON 2/PE 2

PRACTICAL EXERCISE 2

1. Instructions

On a plain sheet of paper, write down the answers to the following questions. When you have answered them, turn the page and check your answers.

2. First Requirement

- a. What are the two most common classifications for glass?
- b. Tempered glass can withstand heavy impacts and great pressures. It is made by reheating plate or window glass until it is somewhat soft followed by cooling it in what manner?
- c. What is the inner material that is placed between two sheets of glass forming laminated safety glass?
- d. What are the three operations that the process of cutting glass is divided into?
- e. Why is it important to keep a constant temperature in a glass cutting room?
- f. What is the liquid that should first be wiped around the cutting line of glass to be cut?
- g. What kind of grain is used to grind glass?
- h. In addition to the use of protective covers and the inspection of hardware, what is the most important general precaution to follow when installing glass?

3. Second Requirement

- a. Automobile and truck radiators consist of two water tanks joined by what component which does the actual cooling?
- b. Radiator fittings are found on both the upper and lower water tanks of the radiator. When they are manufactured as separate parts, what are the four ways they can be attach to the radiator?

METAL BODY REPAIR - OD1653 - LESSON 2/PE 2

- c. What are the two most common types of radiator cores?
- d. Radiator cleaning has three purposes: to restore perfect radiation, to facilitate soldering, and to remove obstructions to water circulation. What are the three methods by which water passages may be cleaned?
- e. How much pressure is required when pressure flushing a radiator?
- f. One method of testing a radiator for leaks is to introduce air (under light pressure) into the radiator and immerse it in water and look for air bubbles. What is another method for testing radiators for leaks?
- g. When disassembling a radiator, an oxyacetylene welding torch is used as a source of heat. The torch is adjusted to what type of flame?
- h. The use of a proper flux, the close union of the parts to be soldered, and the application of adequate heat to make the solder flow freely are important to accomplishing a proper radiator soldering job. What is a good soldering job dependent upon?
- i. What is the composition of soft solder?
- j. The most commonly used flux is hydrochloric acid which has been cut by adding what compound to it?

4. Third Requirement

- a. What is the purpose of having baffles inside a fuel tank?
- b. The process of tinning the inside of a fuel tank prevents what from forming inside the tank.
- c. Of the three possible methods for locating fuel tank leaks, what is considered the best test for this purpose?
- d. Before fuel tank repairs can be performed, fuel tanks must be cleaned thoroughly. The best method for doing this is cleaning the tank with live

METAL BODY REPAIR - OD1653 - LESSON 2/PE 2

steam. With the steam cleaner hose in the filler neck, how long should steam be forced into the tank?

e. Can fuel tanks be repaired by patching the tank?

LESSON 2. PRACTICAL EXERCISE - ANSWERS

1. First Requirement
 - a. (1) Lead glass
(2) Line glass
 - b. Tempered glass is cooled by placing it in a hot oil bath or placing it quickly against a cold metallic surface
 - c. Tough plastic material
 - d. (1) Making the cut
(2) Cracking the cut
(3) Cutting or melting the plastic
 - e. Sudden temperature changes will almost certainly result in breakage of glass
 - f. Kerosene
 - g. Silicon carbide abrasive grain
 - h. Check parts
2. Second Requirement
 - a. Core
 - b. (1) Brazed
(2) Soldered
(3) Bolted
(4) Riveted
 - c. (1) Tubular
(2) Honeycomb
 - d. (1) Pressure flushing
(2) Boiling
(3) Rod cleaning
 - e. Five psi
 - f. Filling the radiator with water and locating the leaks by moisture seeping through
 - g. Carburizing flame

METAL BODY REPAIR - OD1653 - LESSON 2/PE 2

- h. Complete tinning of the metal prior to soldering
- i. 50 percent tin and 50 percent lead
- j. Zinc
- 3. Third Requirement
 - a. To offset excessive splashing and foaming of the fuel when the vehicle is in motion
 - b. Rust
 - c. Underwater air test
 - d. 45 minutes
 - e. Yes

REFERENCES

METAL BODY REPAIR - OD1653 - REFERENCES

REFERENCES

The following documents were used as resource materials in developing this subcourse:

DA Pam 310-1
FM 9-24
FM 43-2
TB 9-2300-247-40
TM 9-237